



WHOLESALE HARDWOOD INTERIORS



Architectural Mouldings & Millwork

WHI

Wholesale Hardwood Interiors, Inc. (WHI) has built its success and reputation upon its dedication to high standards of quality, service, and integrity.

Quality: We are confident that you will be pleased with the quality of material and workmanship you will find with our products. Our reputation is built on the level of expertise we provide.

Service: WHI is committed to the needs of our customers. Our goal is to provide one-on-one assistance through your personal Account Executive to our in-house office and warehouse team so that your project exceeds expectations.

Integrity: From our employees and staff, to our Account Executives, to the products that go out the door, we want your buying experience with WHI to be pleasing from start to finish and conducted with the utmost respect and integrity.

We accept the responsibility to create added value for those who entrust us with their business or home. We strive to effectively meet our customers' ever-changing needs. WHI realizes we must consistently meet the demanding guidelines for quality and service that we developed many years ago and our customers have come to expect.

Wholesale Hardwood Interiors strives to exceed your expectations in quality, service and integrity.

Mike Judd, President





Stock Mouldings

- Casings 2
- Backbands 8
- Header Material 9
- Base Caps 10
- Bases 10
- Crowns 15
- Dentil Crowns 21
- Blocks 23
- Chair Rails 25
- Mulls 25
- Window Stools 26
- Window Stops 26
- Panel & Bed Mouldings 27
- Trim Mouldings 28
- Custom Millwork 30
- Bar Rails 32
- Mantel Mouldings 32
- Beams & Columns 33
- S4S Lumber 34
- Tongue & Groove 35
- Shiplap 37
- Arched Jambs Information 38
- Jambs 40

Primed MDF

- Primed MDF Information 41
- Primed MDF Casings 42
- Primed MDF Bases 43
- Primed MDF Crowns 44
- Primed MDF T&G, Shiplap 47

Primed Pine

- Primed Pine Casings 48
- Primed Pine Bases 49
- Primed Pine Shoe Mouldings 50
- Primed Pine Crowns 51
- Primed Pine Shiplap 52
- Primed Pine Jambs & Stops 53

Species Chart

- CAD to Reality 59
- General Information 60



CASINGS

WHOLESALE HARDWOOD INTERIORS, INC.

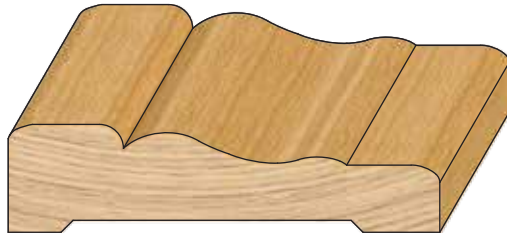

PROFILE #	DIMENSION
1872CA	9/16" x 2 1/4"

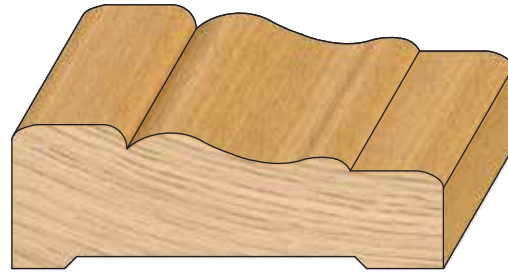

PROFILE #	DIMENSION
2472CA	3/4" x 2 1/4"



PROFILE #	DIMENSION
2472BCA	3/4" x 2 1/4"

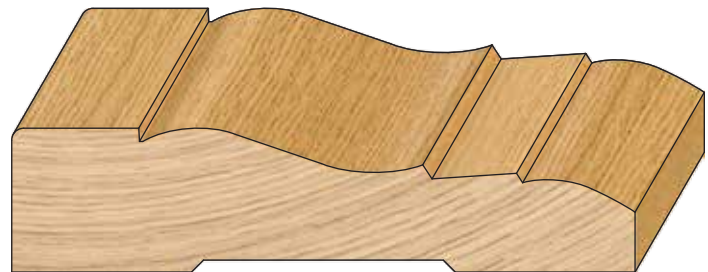

PROFILE #	DIMENSION
24104HNCA	3/4" x 3 1/4"

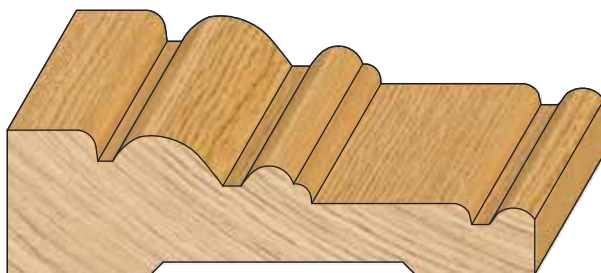

PROFILE #	DIMENSION
2488ECA	3/4" x 2 3/4"

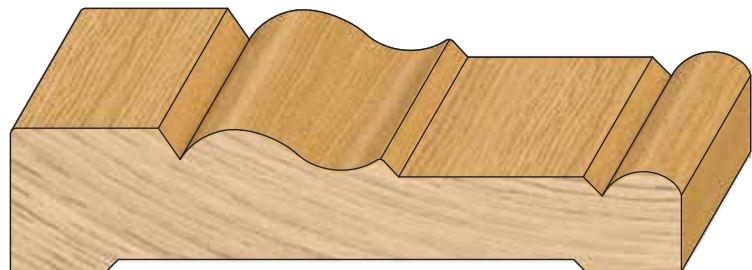

PROFILE #	DIMENSION
24112CCA	3/4" x 3 1/2"

Images shown are displayed to full scale.

MINIMAL DIFFERENCES MAY APPEAR IN SCALED IMAGES.

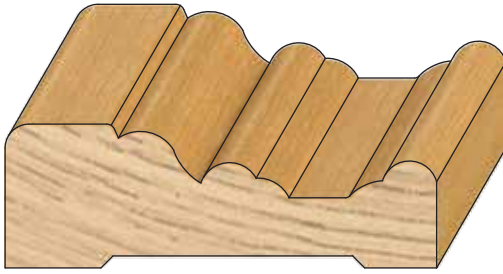

PROFILE #	DIMENSION
2472MWCA	3/4" x 2 1/4"

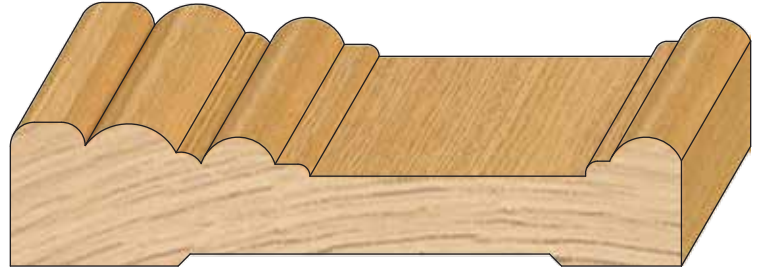

PROFILE #	DIMENSION
24112WCA	3/4" x 3 1/2"

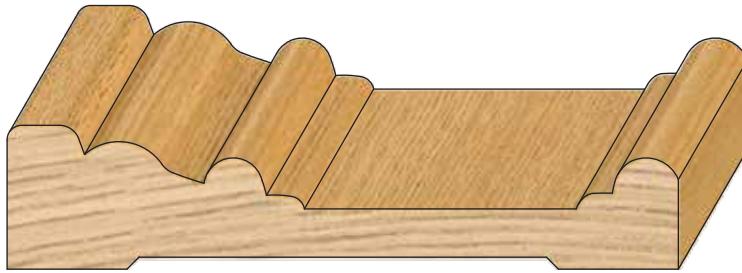

PROFILE #	DIMENSION
24112CA	3/4" x 3 1/2"

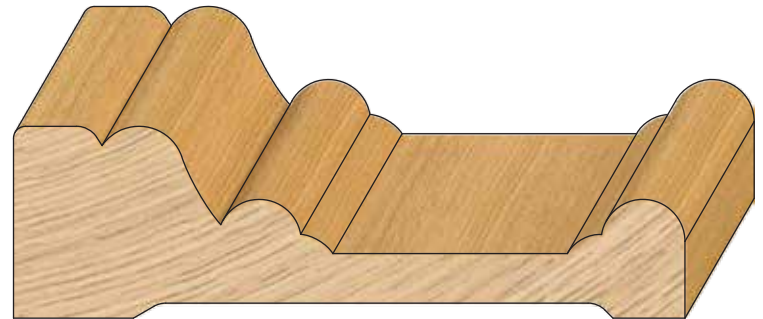

PROFILE #	DIMENSION
32112HCA	1" x 3 1/2"

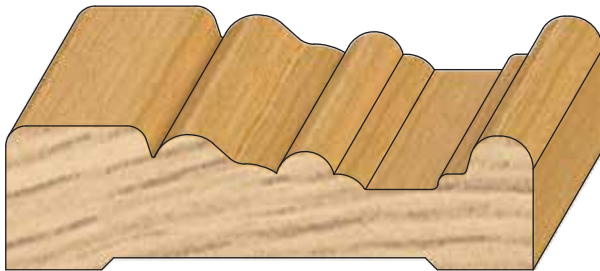

PROFILE #	DIMENSION
2488CA	3/4" x 2 3/4"

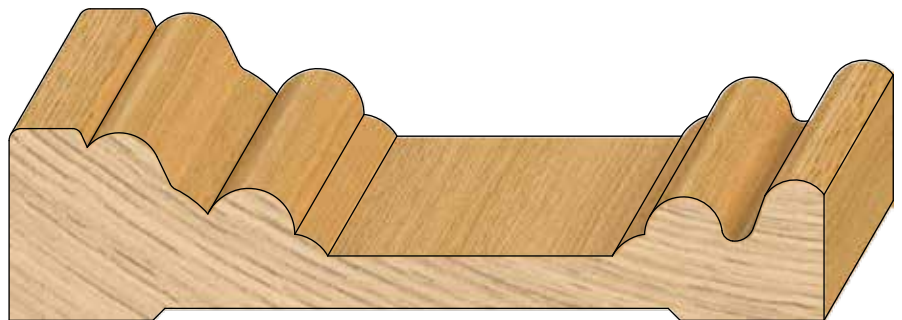

PROFILE #	DIMENSION
32136CA	1" x 4 1/4"

A variety of wood species are available.

SEE SPECIES CHART ON PAGES 54-58.



CASINGS

WHOLESALE HARDWOOD INTERIORS, INC.



PROFILE #	DIMENSION
24104BVCA	3/4" x 3 1/4"

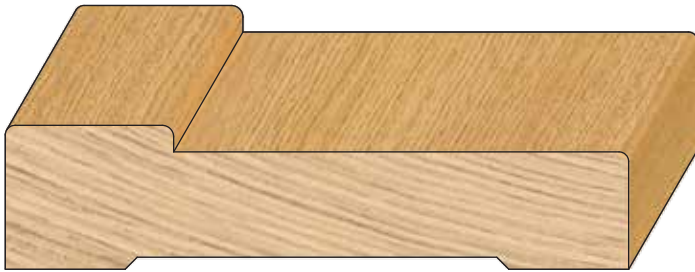

PROFILE #	DIMENSION
24104DD1CA	3/4" x 3 1/4"



PROFILE #	DIMENSION
2488R18CA	3/4" x 2 3/4"



PROFILE #	DIMENSION
24112R18CA	3/4" x 3 1/2"



PROFILE #	DIMENSION
24136R18CA	3/4" x 4 1/4"

Images shown are displayed to full scale.

MINIMAL DIFFERENCES MAY APPEAR IN SCALED IMAGES.

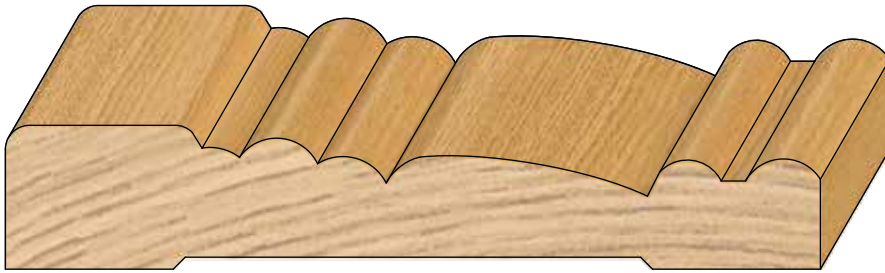

PROFILE # DIMENSION
24136ECA 3/4" x 4 1/4"

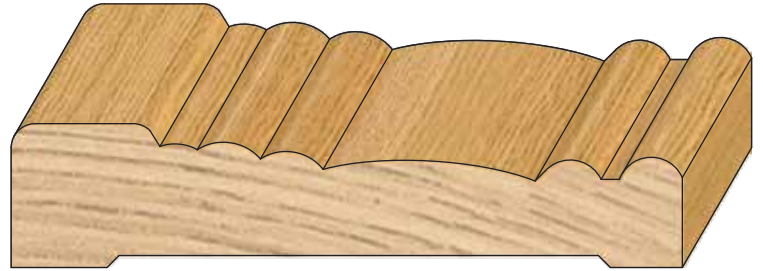

PROFILE # DIMENSION
24112ECA 3/4" x 3 1/2"

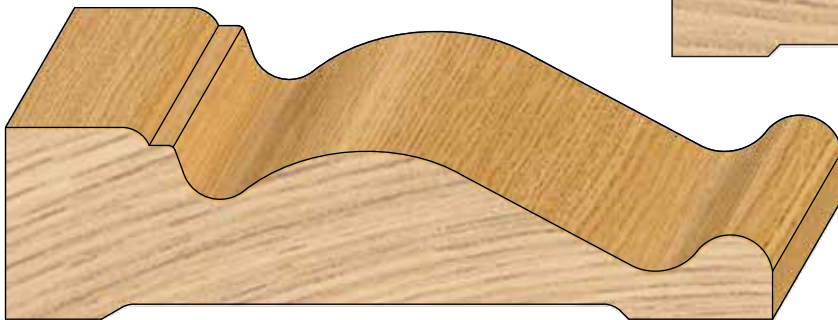

PROFILE # DIMENSION
32128GCA 1" x 4"

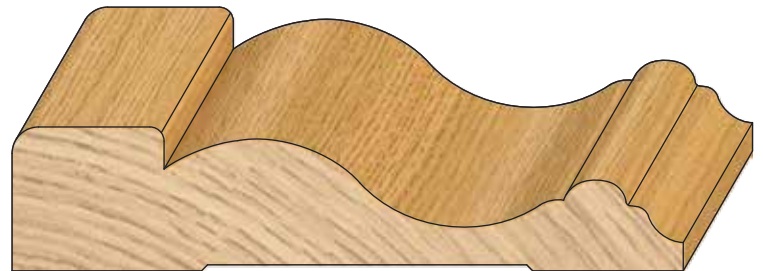

PROFILE # DIMENSION
24112BHCA 3/4" x 3 1/2"

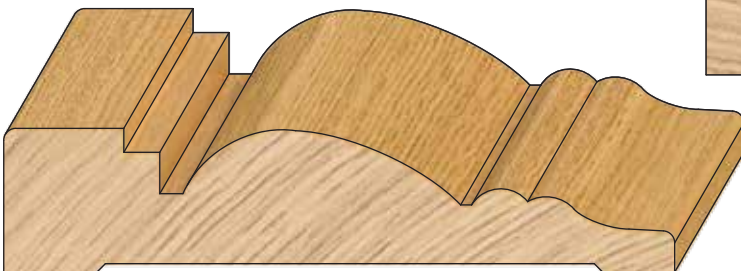

PROFILE # DIMENSION
24112PCA 3/4" x 3 1/2"

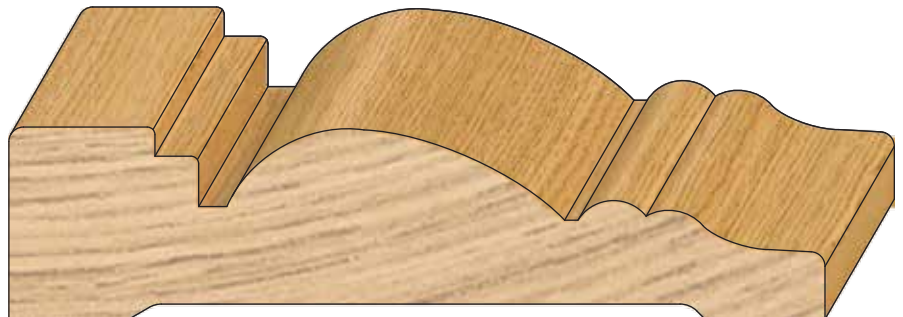

PROFILE # DIMENSION
32136PCA 1" x 4 1/4"

A variety of wood species are available.

SEE SPECIES CHART ON PAGES 54-58.



CASINGS

WHOLESALE HARDWOOD INTERIORS, INC.

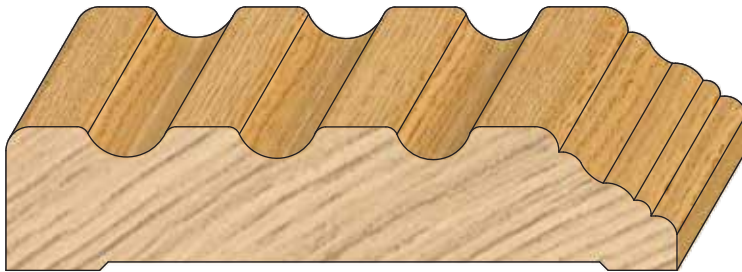

PROFILE #	DIMENSION
24112FCA	3/4" X 3 1/2"

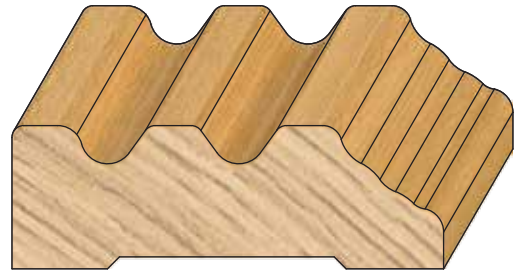

PROFILE #	DIMENSION
2472FCA	3/4" X 2 1/4"

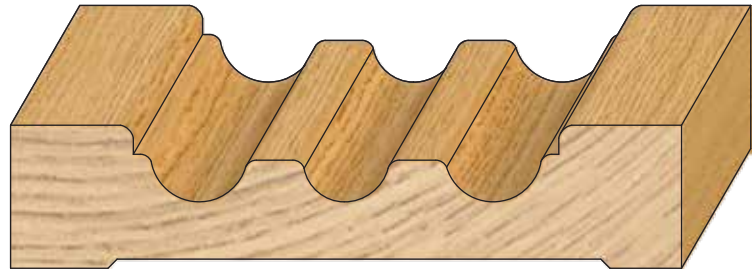

PROFILE #	DIMENSION
24112RFCA	3/4" X 3 1/2"

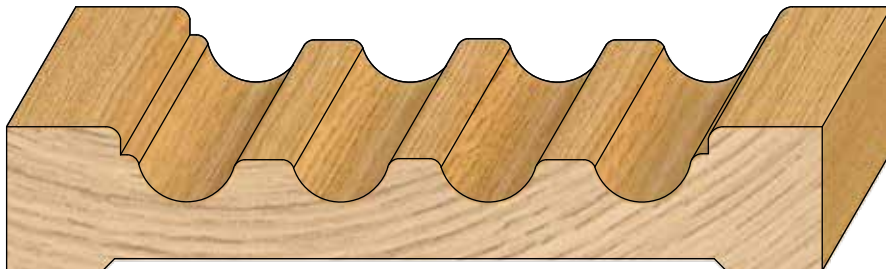

PROFILE #	DIMENSION
24136RFCA	3/4" X 4 1/4"

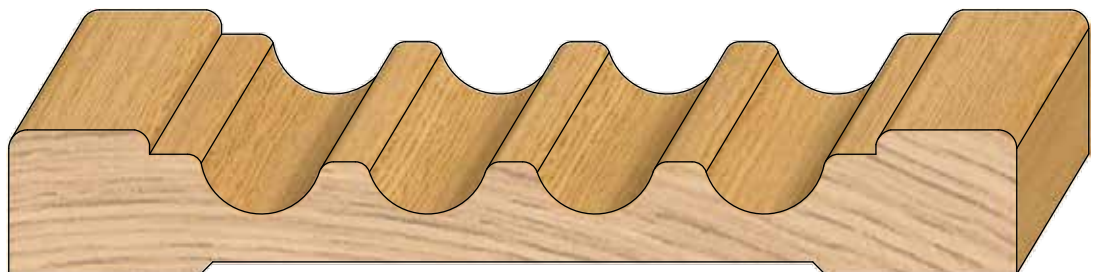

PROFILE #	DIMENSION
24168RFCA	3/4" X 5 1/4"

Images shown are displayed to full scale.

MINIMAL DIFFERENCES MAY APPEAR IN SCALED IMAGES.

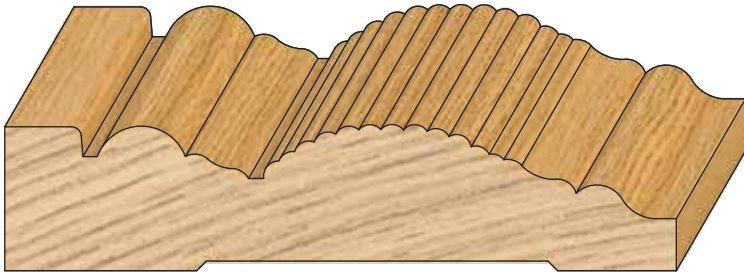

PROFILE #	DIMENSION
24112RDCA	3/4" X 3 1/2"

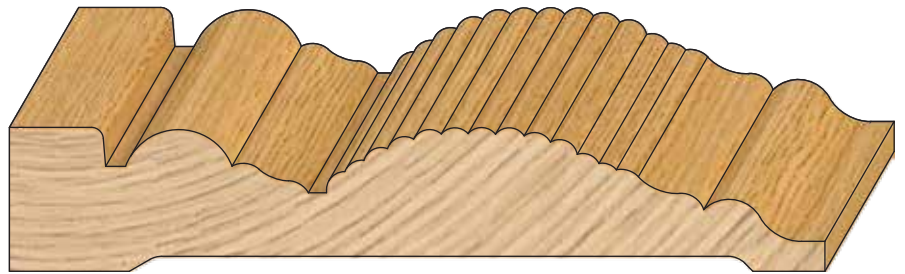

PROFILE #	DIMENSION
24136RDCA	3/4" X 4 1/4"

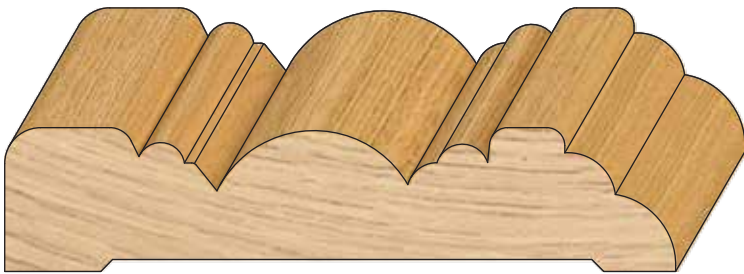

PROFILE #	DIMENSION
24112BCA	3/4" X 3 1/2"

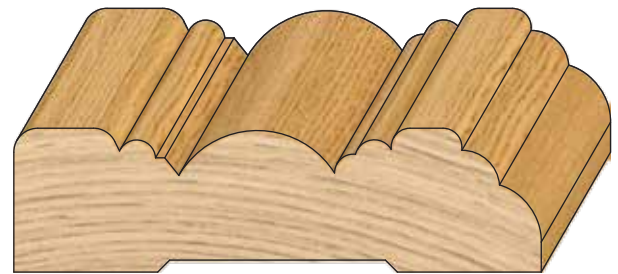

PROFILE #	DIMENSION
2488BCA	3/4" X 2 3/4"

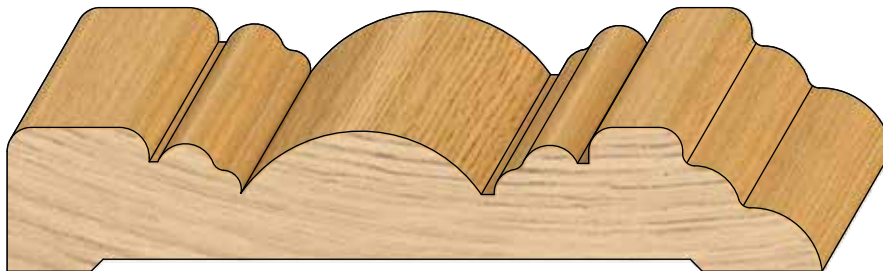

PROFILE #	DIMENSION
24136BCA	3/4" X 4 1/4"

A variety of wood species are available.

SEE SPECIES CHART ON PAGES 54-58.



BACKBANDS

WHOLESALE HARDWOOD INTERIORS, INC.

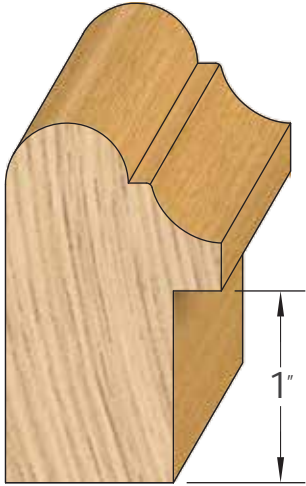

PROFILE # DIMENSION
3660BB 1 1/8" x 1 7/8"
* 1/4" x 1" RABBET.

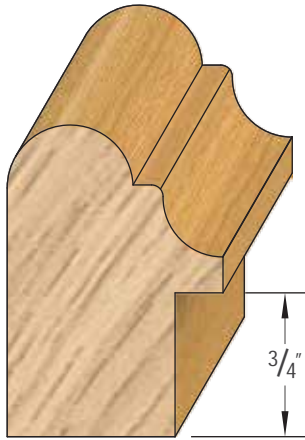

PROFILE # DIMENSION
3652BB 1 1/8" x 1 5/8"
* 1/4" x 3/4" RABBET.

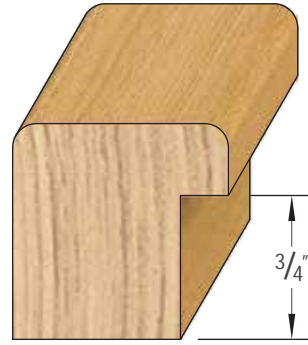

PROFILE # DIMENSION
3636EEBB 1 1/8" x 1 1/8"
* 1/4" x 3/4" RABBET.

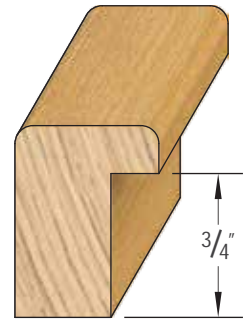

PROFILE # DIMENSION
2432EGBB 3/4" x 1"
* 1/4" x 3/4" RABBET.

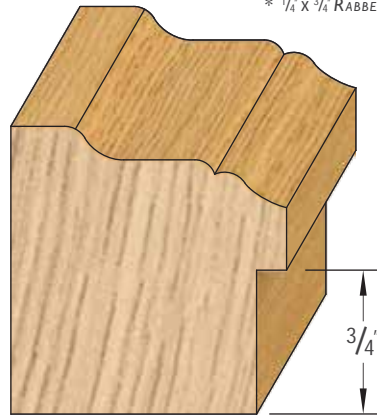

PROFILE # DIMENSION
4648BB 1 7/16" x 1 1/2"
* 5/16" x 3/4" RABBET.

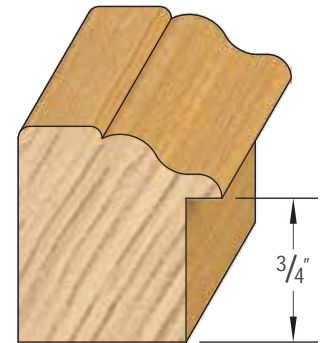

PROFILE # DIMENSION
3436BB 1 1/16" x 1 1/8"
* 3/16" x 3/4" RABBET.

BACKBAND
4864BB
IS DISPLAYED ON
PAGE 9.

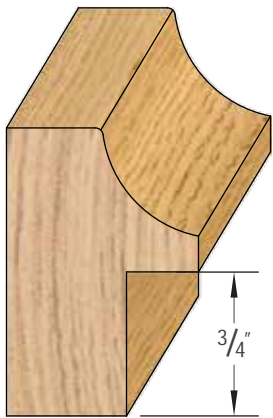

PROFILE # DIMENSION
3248ITBB 1" x 1 1/2"
* 3/8" x 3/4" RABBET.

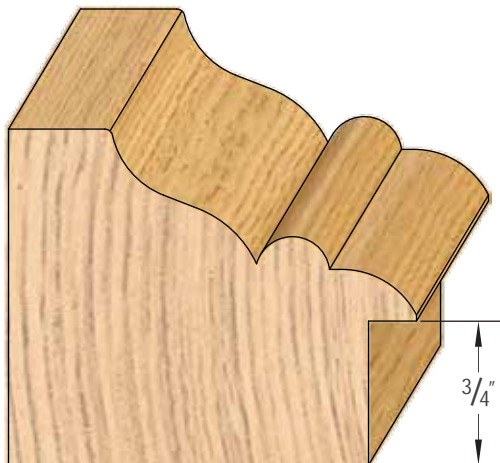

PROFILE # DIMENSION
5668BB 2 1/8" x 1 3/4"
* 1/4" x 3/4" RABBET.



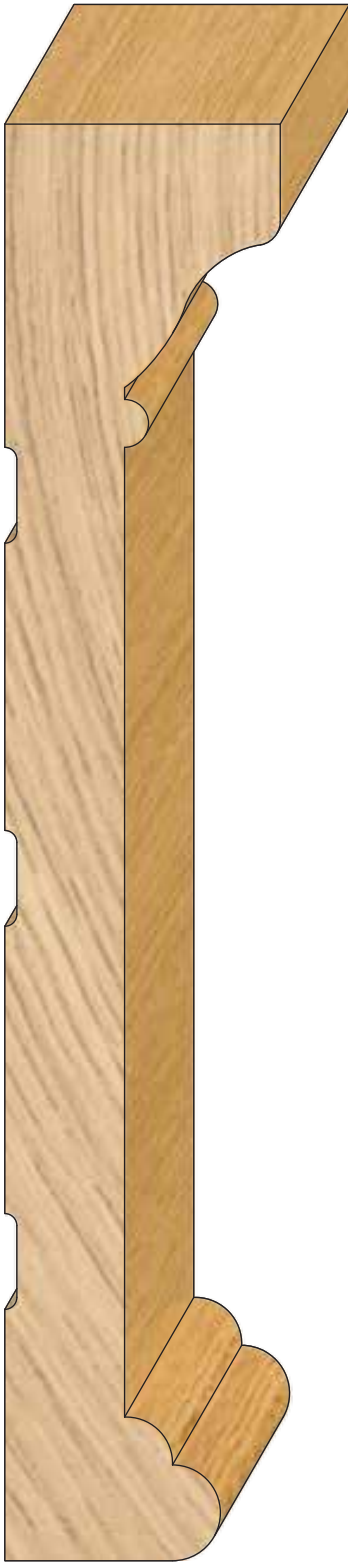

PROFILE # DIMENSION
PG46240HM 1 7/16" x 7 1/2"

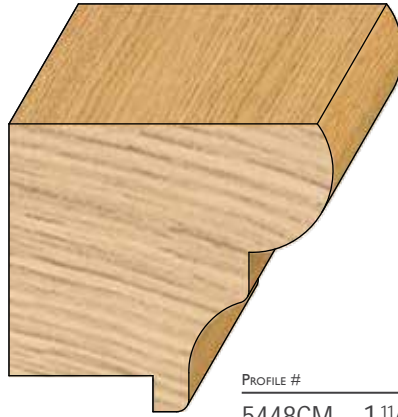

PROFILE # DIMENSION
5448CM 1 11/16" x 1 1/2"
* 3/16" x 3/4" RABBET.



PROFILE # DIMENSION
4864BB 1 1/2" x 2"
* 3/16" x 3/4" RABBET.



PROFILE # DIMENSION
24176S4S 3/4" x 5 1/4"
* A VARIETY OF S4S OPTIONS ARE AVAILABLE ON PAGE 34.



PROFILE # DIMENSION
S4S14S 3/4" x 3 1/2"
* A VARIETY OF S4S OPTIONS ARE AVAILABLE ON PAGE 34.



PROFILE # DIMENSION
1640BN 1/2" x 1 1/4"



PROFILE # DIMENSION
1640BN 1/2" x 1 1/4"

Header Material

Select from WHI's pre-made header material for doors, windows, and openings, or create a custom design with the combination of a backband or cap mould, S4S, and bullnose trim.



BASE CAPS & BASES

WHOLESALE HARDWOOD INTERIORS, INC.



PROFILE # DIMENSION
1723BDBC $1\frac{17}{32}'' \times 2\frac{23}{32}''$



PROFILE # DIMENSION
2148CB $2\frac{1}{32}'' \times 1\frac{1}{2}''$



PROFILE # DIMENSION
2244BC $1\frac{1}{16}'' \times 1\frac{3}{8}''$



PROFILE # DIMENSION
2250BJB $1\frac{1}{16}'' \times 1\frac{9}{16}''$



PROFILE # DIMENSION
14136BVB $\frac{7}{16}'' \times 4\frac{1}{4}''$



PROFILE # DIMENSION
14168BVB $\frac{7}{16}'' \times 5\frac{1}{4}''$



PROFILE # DIMENSION
18104OGB $\frac{9}{16}'' \times 3\frac{1}{4}''$



PROFILE # DIMENSION
18136OGB $\frac{9}{16}'' \times 4\frac{1}{4}''$



PROFILE # DIMENSION
18168OGB $\frac{9}{16}'' \times 5\frac{1}{4}''$

Images shown are displayed to full scale.

MINIMAL DIFFERENCES MAY APPEAR IN SCALED IMAGES.

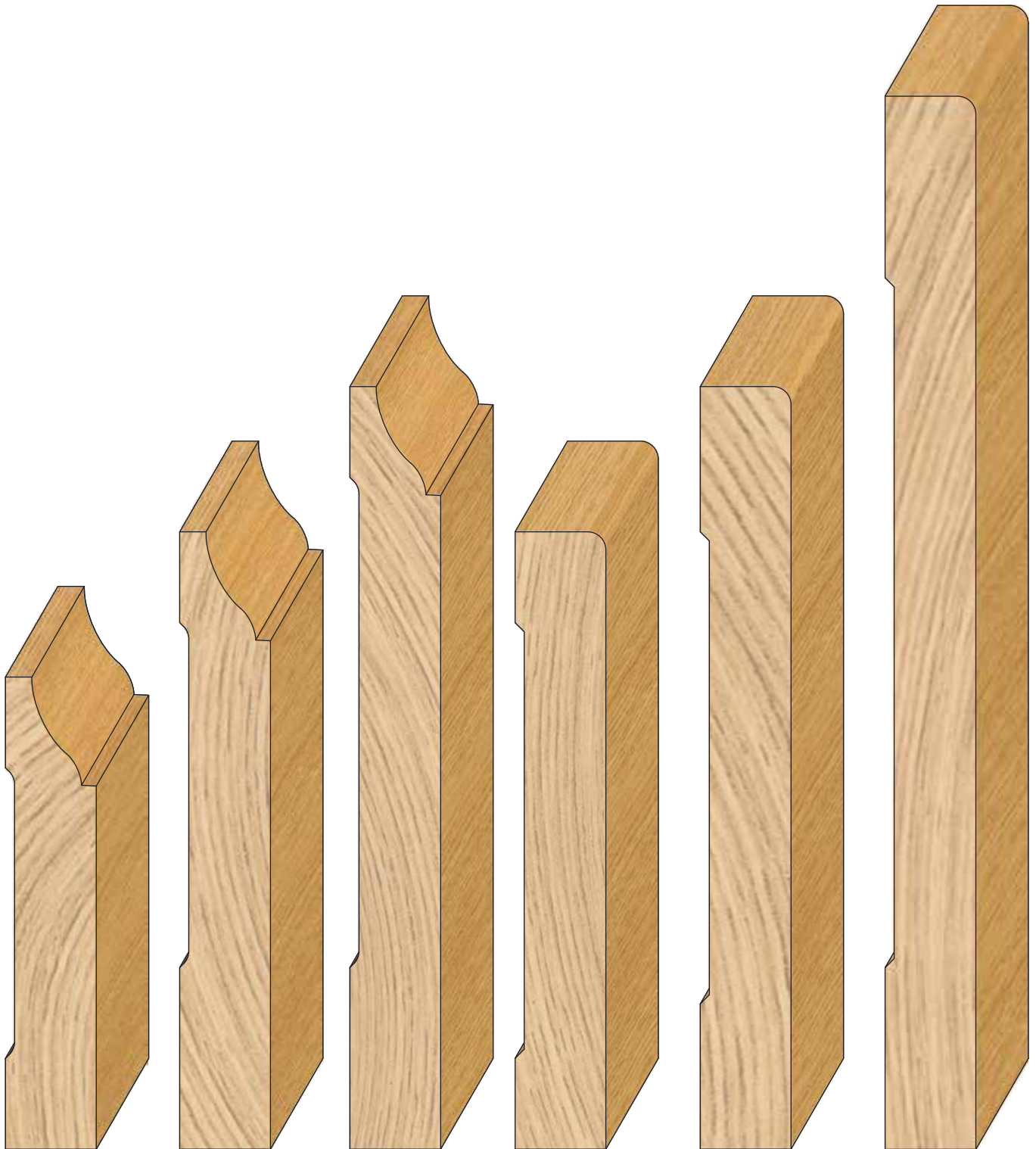

PROFILE #	DIMENSION	PROFILE #	DIMENSION	PROFILE #	DIMENSION	PROFILE #	DIMENSION	PROFILE #	DIMENSION	PROFILE #	DIMENSION
20104BB	5/8" x 3 1/4"	20136BB	5/8" x 4 1/4"	20168BB	5/8" x 5 1/4"	20136R18B	5/8" x 4 1/4"	20168R18B	5/8" x 5 1/4"	20232R18B	5/8" x 7 1/4"

A variety of wood species are available.

SEE SPECIES CHART ON PAGES 54-58.



BASES

WHOLESALE HARDWOOD INTERIORS, INC.

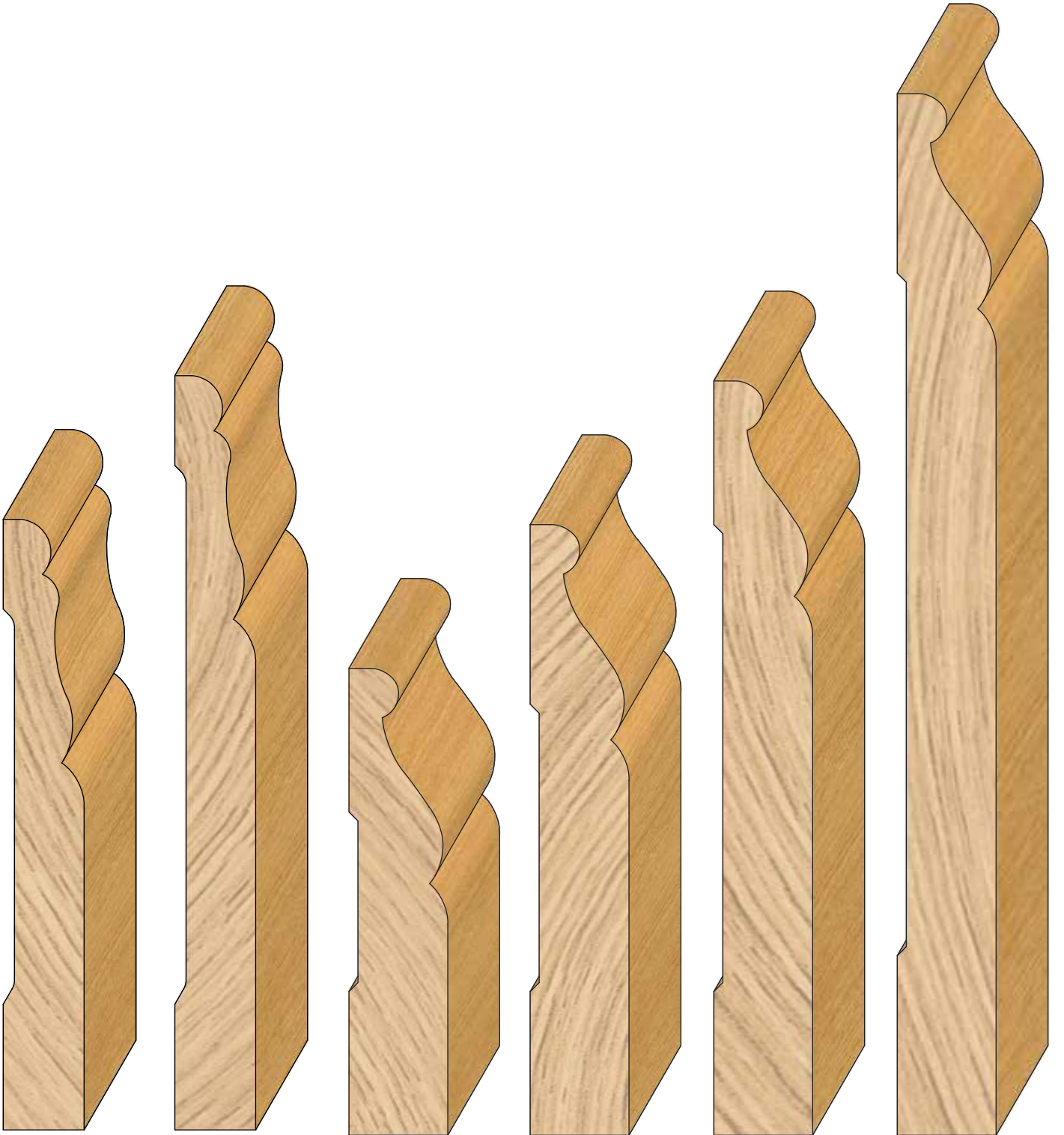

PROFILE # DIMENSION
18136B 9/16" x 4 1/4"

PROFILE # DIMENSION
18168B 9/16" x 5 1/4"

PROFILE # DIMENSION
22104CB 1 1/16" x 3 1/4"

PROFILE # DIMENSION
22136CB 1 1/16" x 4 1/4"

PROFILE # DIMENSION
22168CB 1 1/16" x 5 1/4"

PROFILE # DIMENSION
22232CB 1 1/16" x 7 1/4"

Images shown are displayed to full scale.

MINIMAL DIFFERENCES MAY APPEAR IN SCALED IMAGES.



PROFILE # DIMENSION
20168BDB 5/8" x 5 1/4"



PROFILE # DIMENSION
20232BDB 5/8" x 7 1/4"



PROFILE # DIMENSION
24112BDB 3/4" x 3 1/2"



PROFILE # DIMENSION
24168BDB 3/4" x 5 1/4"



PROFILE # DIMENSION
24232BDB 3/4" x 7 1/4"

A variety of wood species are available.

SEE SPECIES CHART ON PAGES 54-58.



BASES

WHOLESALE HARDWOOD INTERIORS, INC.

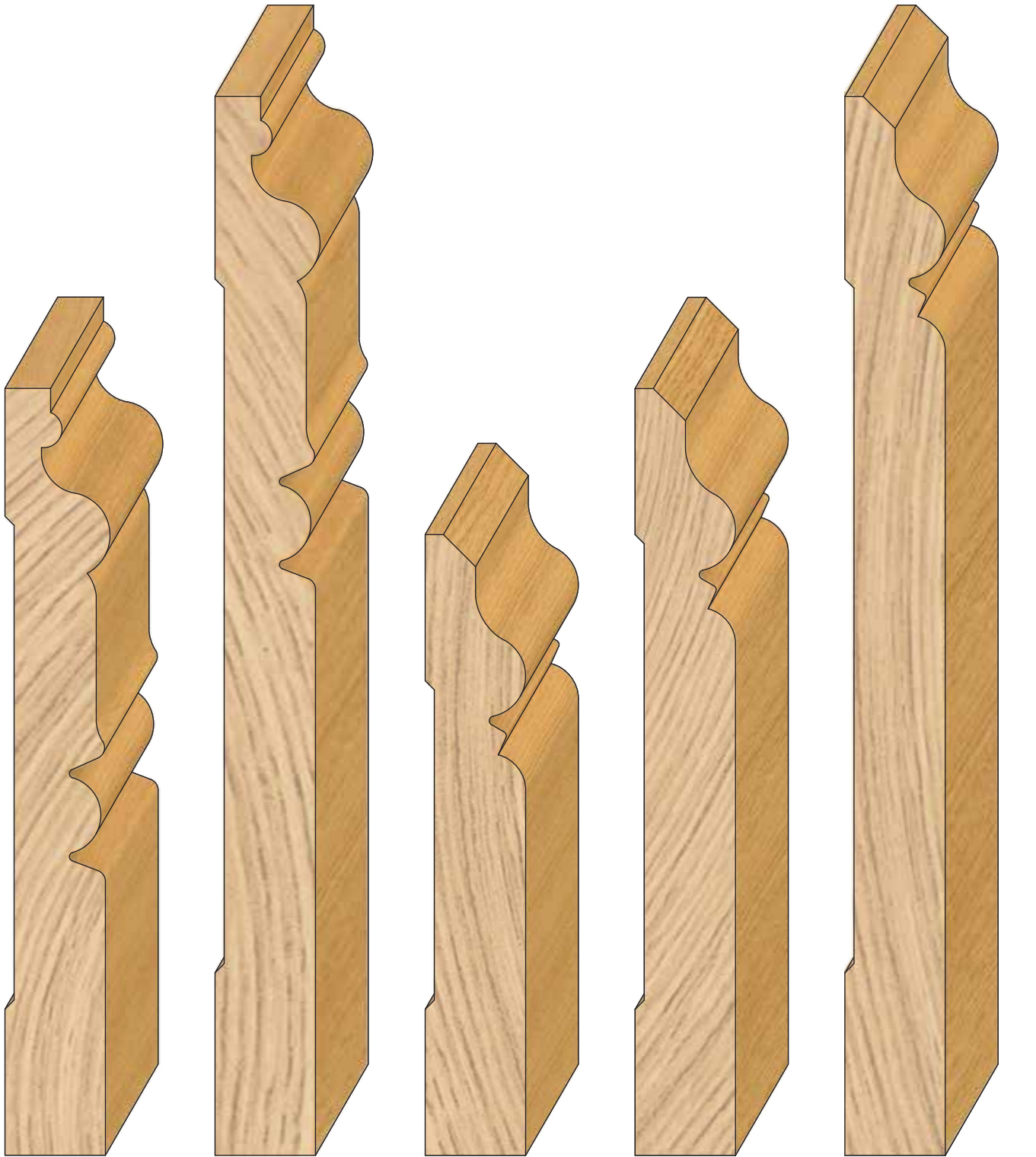

PROFILE # DIMENSION
22168EB 1 1/16" X 5 1/4"

PROFILE # DIMENSION
22232EB 1 1/16" X 7 1/4"

PROFILE # DIMENSION
22136BJB 1 1/16" X 4 1/4"

PROFILE # DIMENSION
22168BJB 1 1/16" X 5 1/4"

PROFILE # DIMENSION
22232BJB 1 1/16" X 7 1/4"

Images shown are displayed to full scale.

MINIMAL DIFFERENCES MAY APPEAR IN SCALED IMAGES.

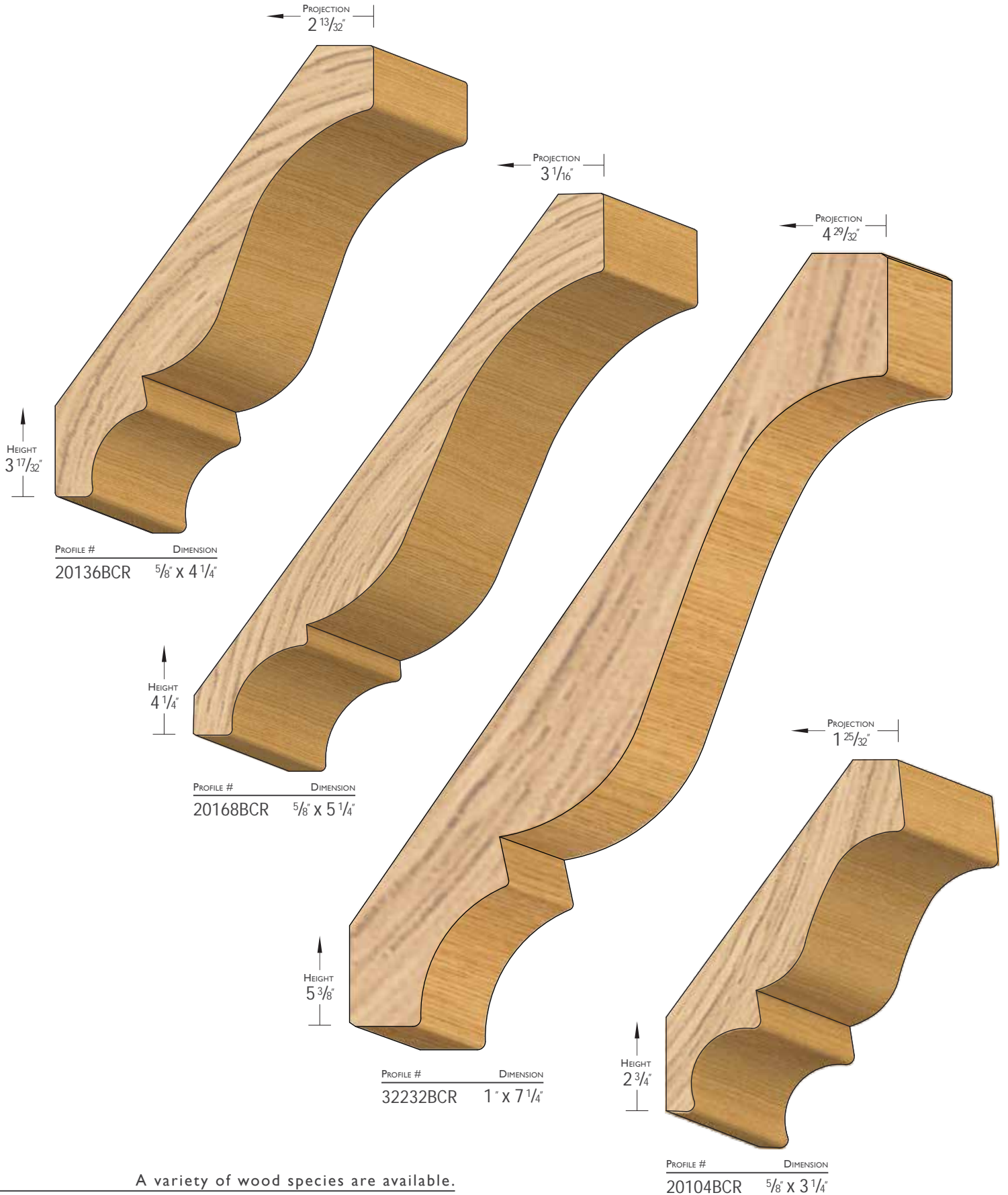

A variety of wood species are available.

SEE SPECIES CHART ON PAGES 54-58.



CROWNS

WHOLESALE HARDWOOD INTERIORS, INC.

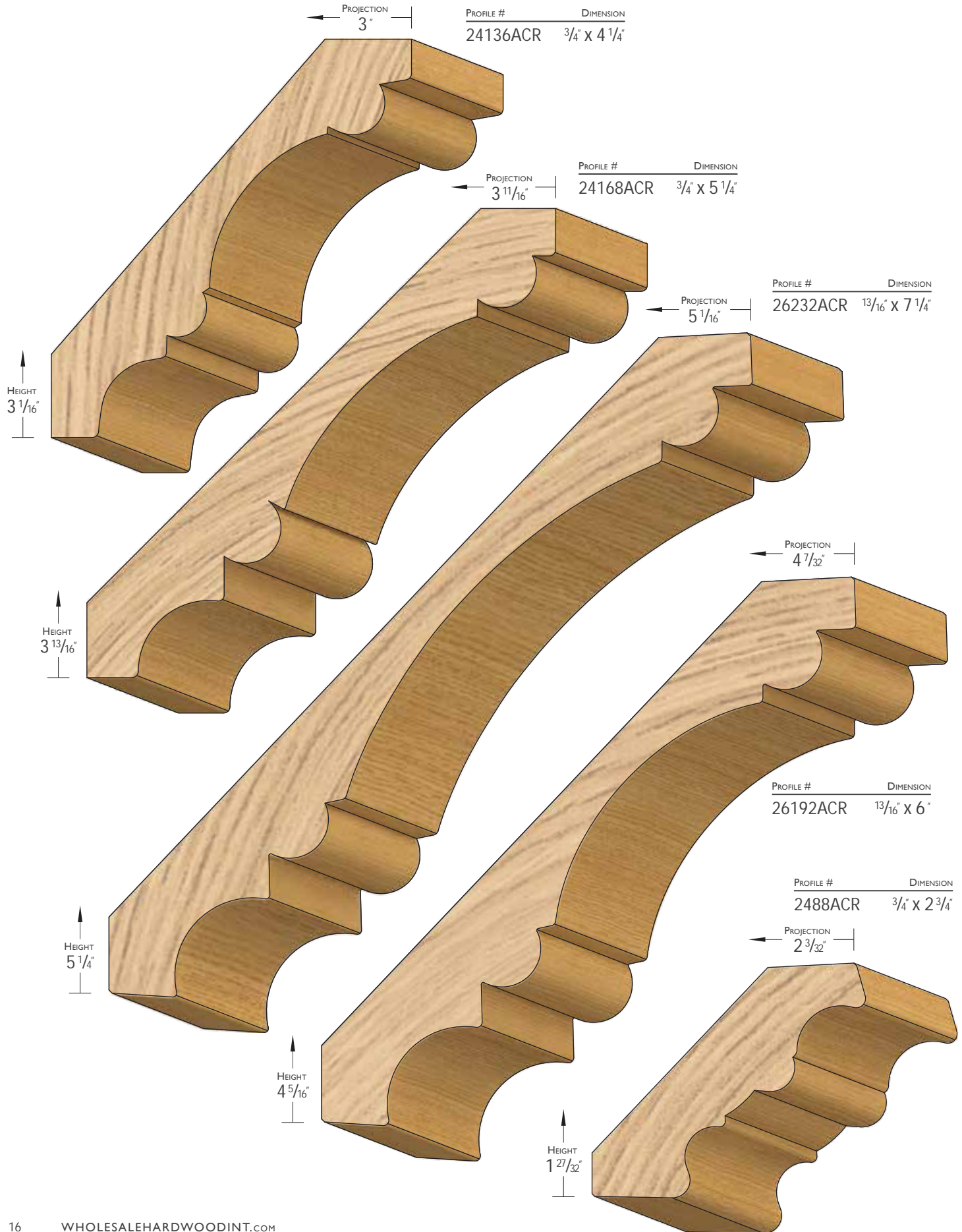

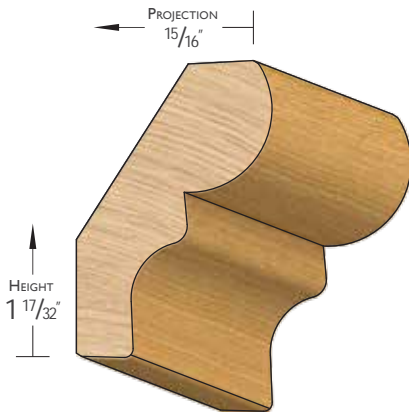

PROFILE #	DIMENSION
1857CR	9/16" X 1 25/32"

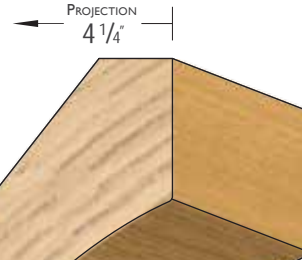

PROFILE #	DIMENSION
24232WCR	3/4" X 7 1/4"



PROFILE #	DIMENSION
32232ACR	1" X 7 1/4"

A variety of wood species are available.

SEE SPECIES CHART ON PAGES 54-58.



CROWNS

WHOLESALE HARDWOOD INTERIORS, INC.

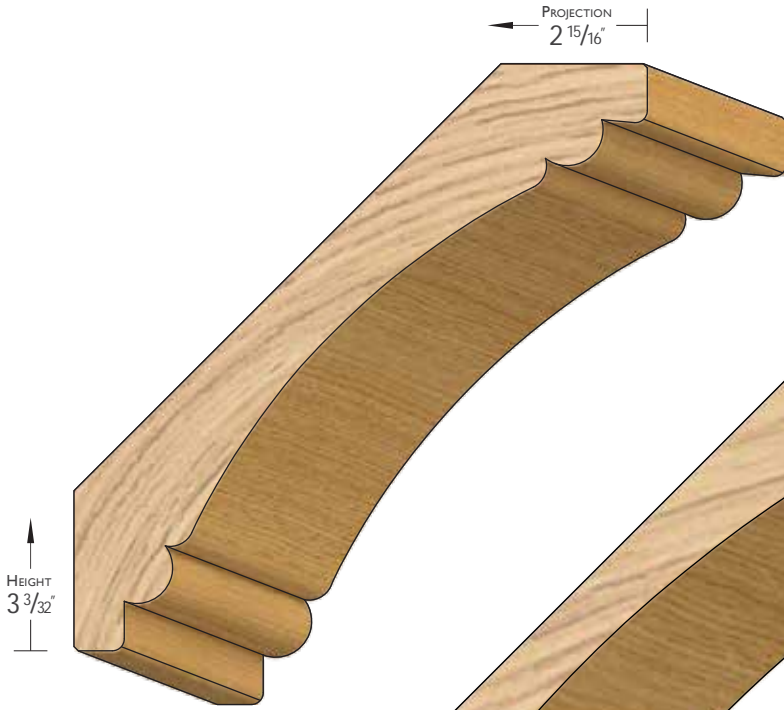

PROFILE #	DIMENSION
24136CCR	3/4" X 4 1/4"

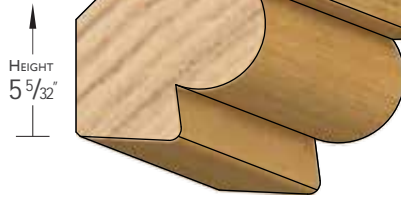
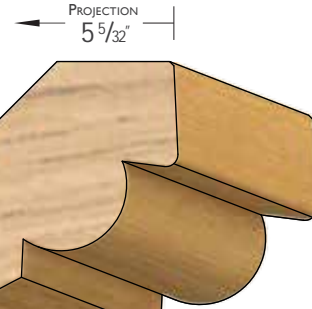

PROFILE #	DIMENSION
26232CCR	13/16" X 7 1/4"

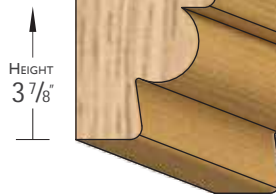
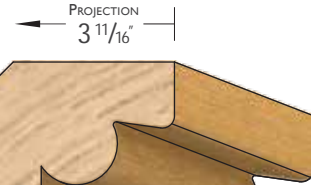

PROFILE #	DIMENSION
26168CCR	13/16" X 5 1/4"

Images shown are displayed to full scale.

MINIMAL DIFFERENCES MAY APPEAR IN SCALED IMAGES.



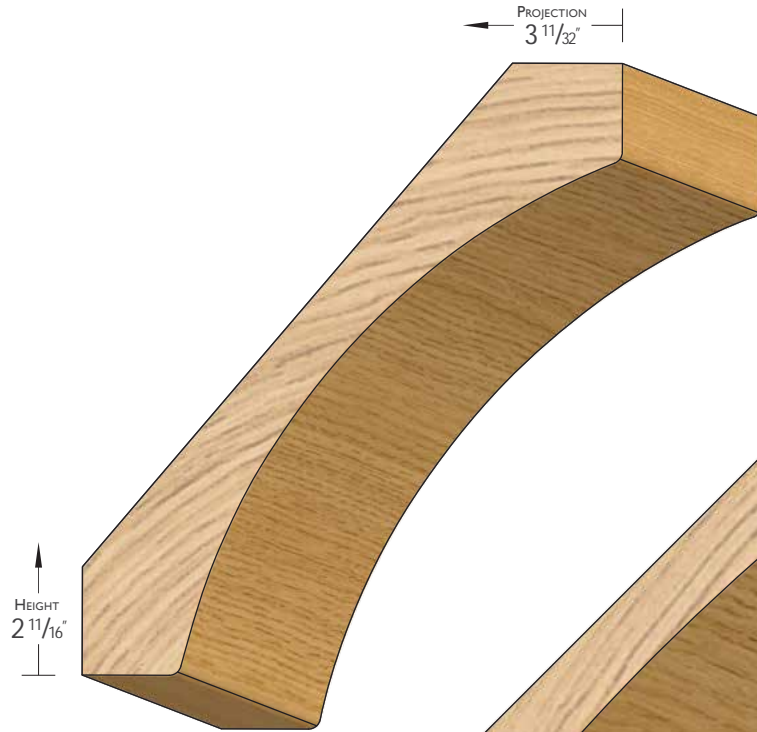

PROFILE #	DIMENSION
24136CVCR	$\frac{3}{4}$ " x $4 \frac{1}{4}$ "

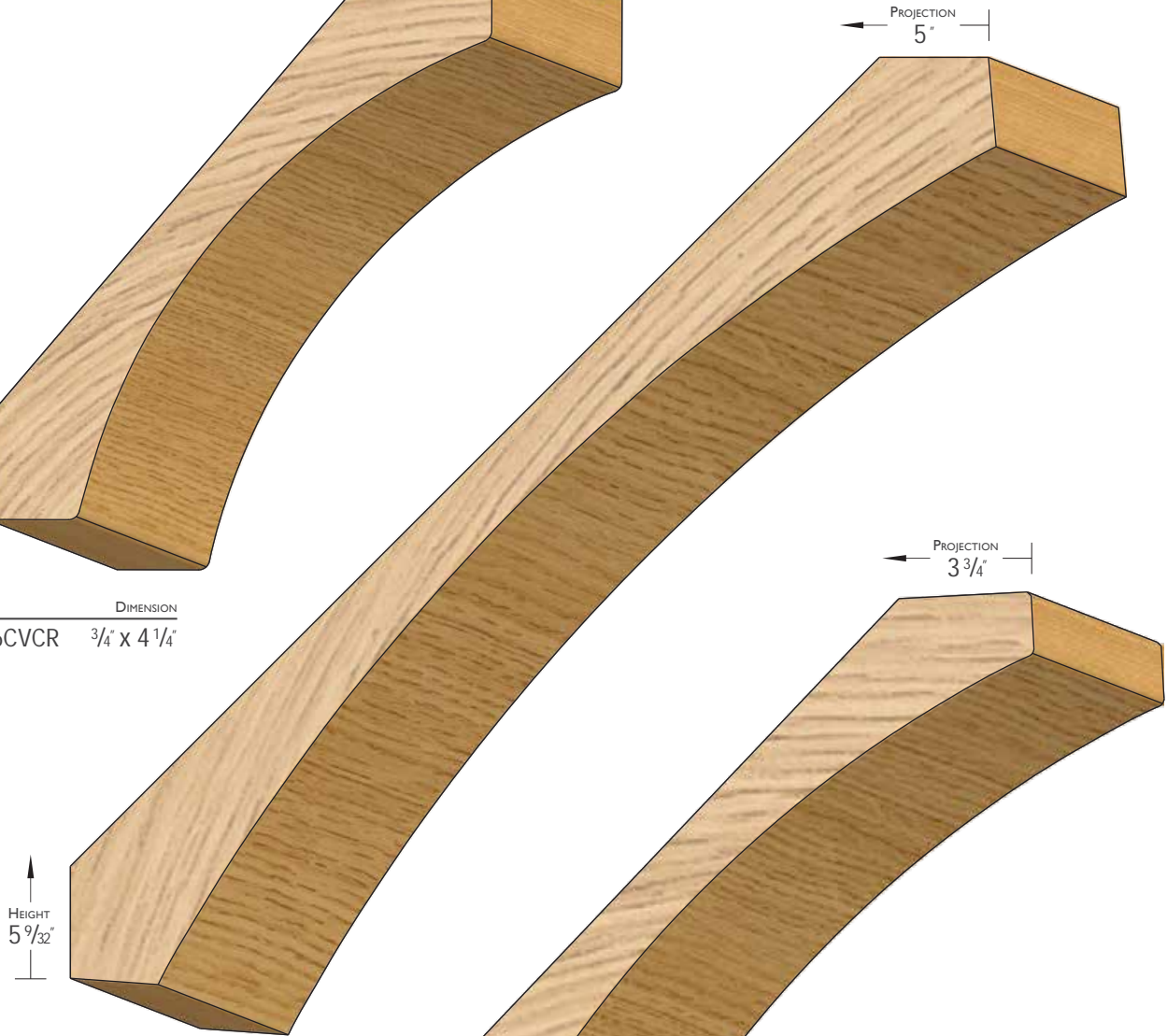

PROFILE #	DIMENSION
26232CVCR	$1 \frac{3}{16}$ " x $7 \frac{1}{4}$ "

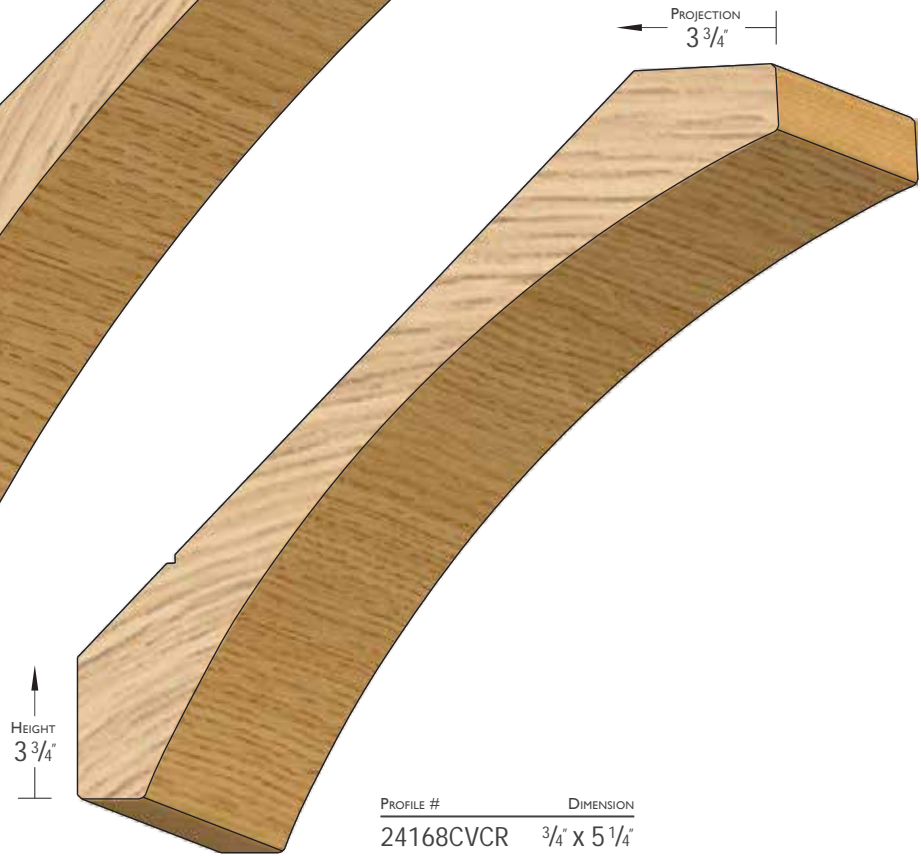

PROFILE #	DIMENSION
24168CVCR	$\frac{3}{4}$ " x $5 \frac{1}{4}$ "

Images shown are displayed to full scale.

MINIMAL DIFFERENCES MAY APPEAR IN SCALED IMAGES.

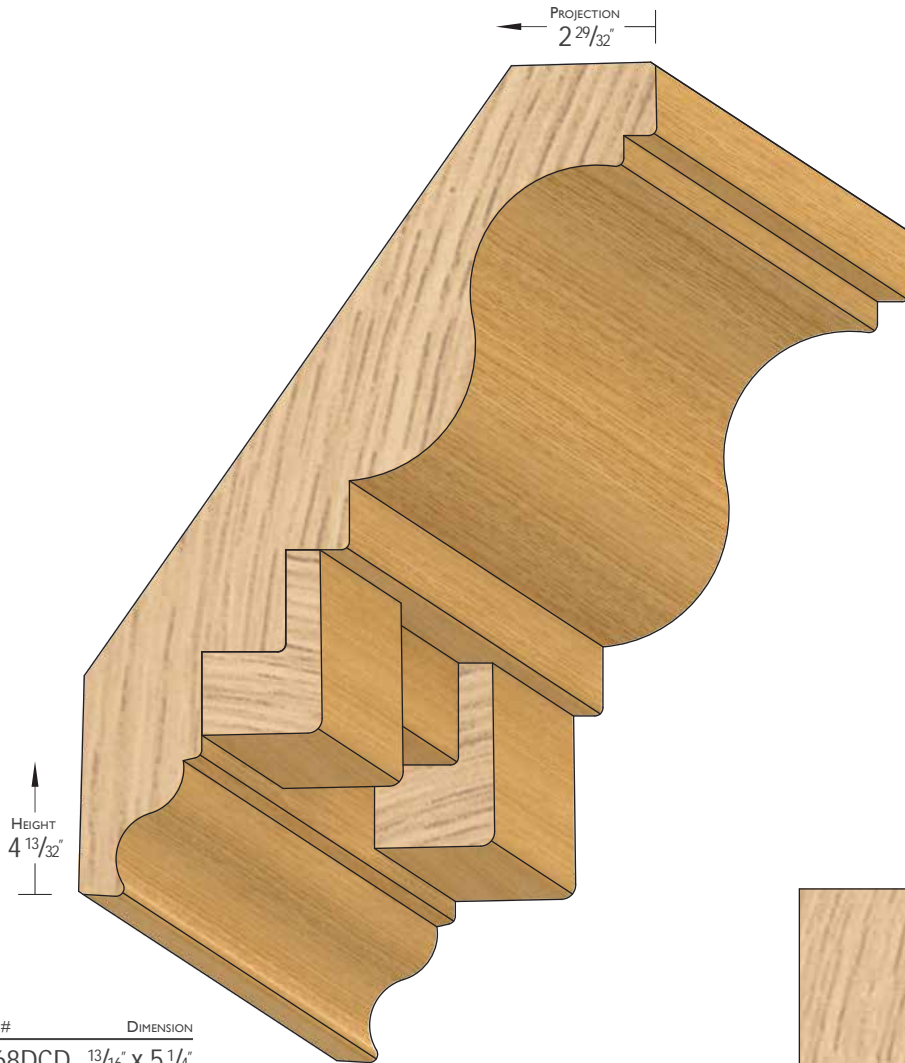

PROFILE # DIMENSION
26168DCD 1 3/16" x 5 1/4"

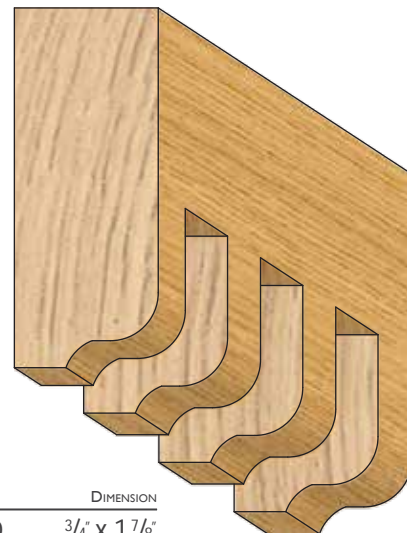

PROFILE # DIMENSION
2460CD 3/4" x 1 7/8"

A variety of wood species are available.

SEE SPECIES CHART ON PAGES 54-58.



DENTIL CROWNS

WHOLESALE HARDWOOD INTERIORS, INC.

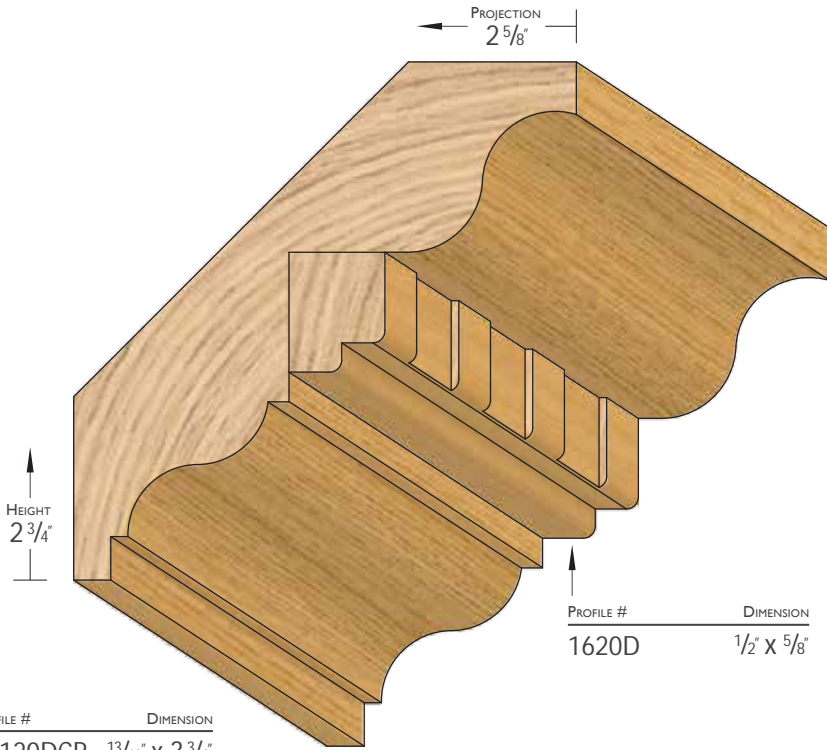

**1620D &
1724ROPE MUST BE
APPLIED TO CROWN
ON SITE.**



Images shown are displayed to full scale.

MINIMAL DIFFERENCES MAY APPEAR IN SCALED IMAGES.

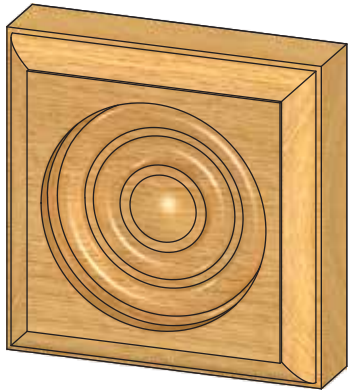

PRODUCT DESCRIPTION
Dish Rosette

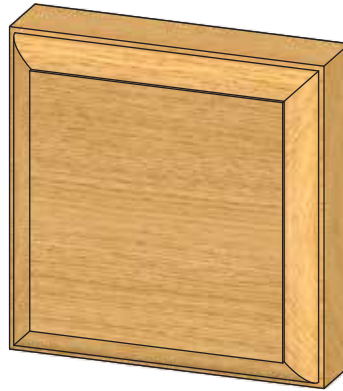

PRODUCT DESCRIPTION
Plain Rosette



PRODUCT DESCRIPTION
Plinth Block

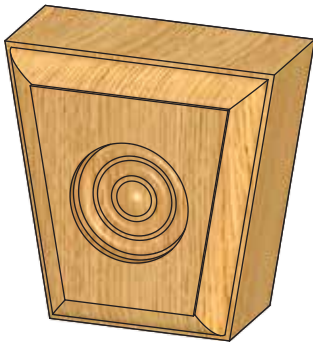

PRODUCT DESCRIPTION
Dish Keystone

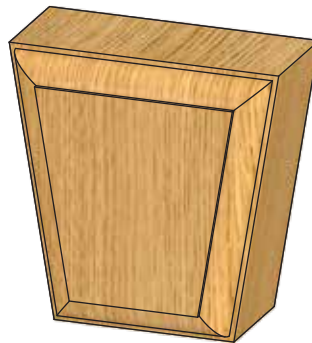

PRODUCT DESCRIPTION
Plain Keystone

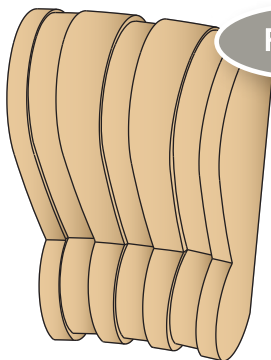

PRODUCT DESCRIPTION
Bear Claw Keystone

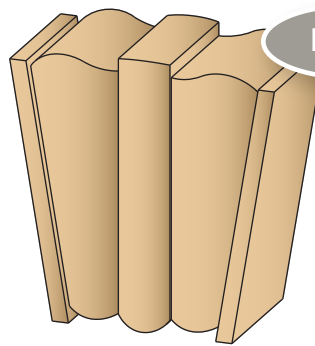

PRODUCT DESCRIPTION
Reeded Keystone

IMAGES ARE NOT
DRAWN TO FULL
SCALE.

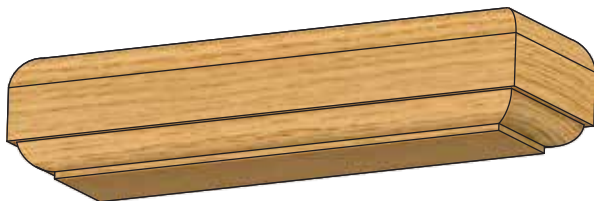

PRODUCT DESCRIPTION
Mantel Cap

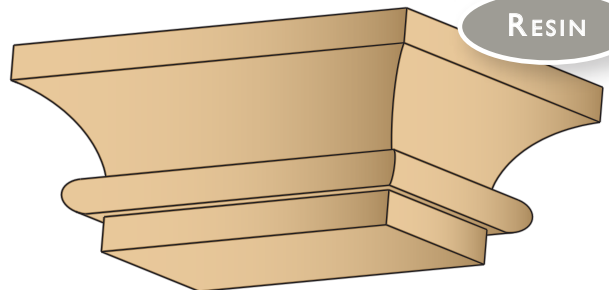

PRODUCT DESCRIPTION
Cap Block

A variety of sizes and wood species are available.

RESIN PRODUCTS ARE PAINT-GRADE & ARE NOT AVAILABLE IN ALTERNATE WOOD SPECIES.
CALL OR CONTACT YOUR ACCOUNT EXECUTIVE FOR DETAILS.



PRODUCT DESCRIPTION	DIMENSION
Routed Crown Block	4" x 4" x 8 1/2" 5" x 5" x 10"

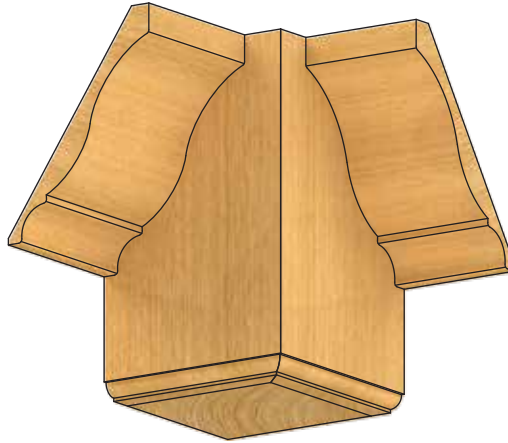

PRODUCT DESCRIPTION	DIMENSION
Hollow Crown Block	4" x 4" x 6 1/2"

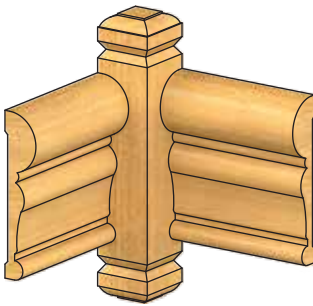
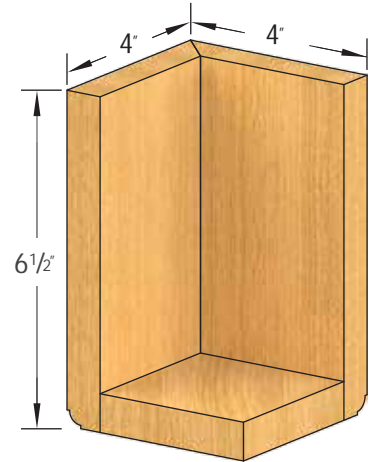

PRODUCT DESCRIPTION	DIMENSION
Inside - Routed Chair Rail Block	1 1/8" x 1 1/8" x 5 1/2"

IMAGES ARE NOT
DRAWN TO FULL
SCALE.

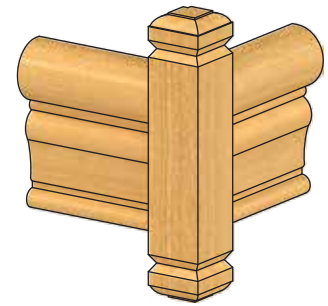

PRODUCT DESCRIPTION	DIMENSION
Outside - Routed Chair Rail Block	1 1/8" x 1 1/8" x 5 1/2"

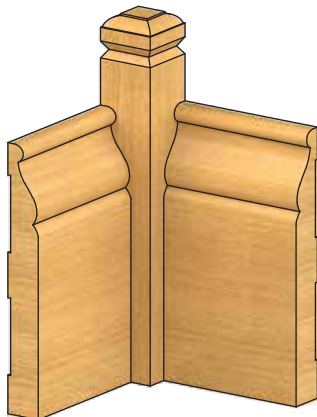

PRODUCT DESCRIPTION	DIMENSION
Inside - Routed Base Block	1 1/8" x 1 1/8" x 7" 1 1/8" x 1 1/8" x 10"

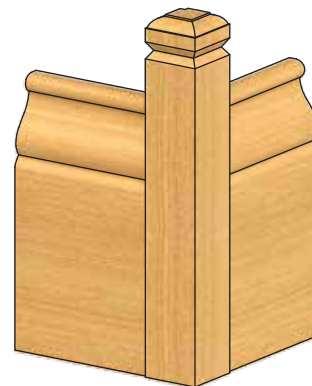

PRODUCT DESCRIPTION	DIMENSION
Outside - Routed Base Block	1 1/8" x 1 1/8" x 7" 1 1/8" x 1 1/8" x 10"

A variety of sizes and wood species are available.

CALL OR CONTACT YOUR ACCOUNT EXECUTIVE FOR DETAILS.

CHAIR RAILS & MULLS



ARCHITECTURAL MOULDINGS & MILLWORK



PROFILE # DIMENSION
20168CHB $\frac{5}{8}$ " x $5\frac{1}{4}$ "

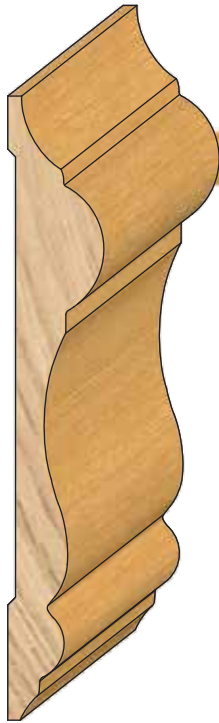

PROFILE # DIMENSION
16104CH $\frac{1}{2}$ " x $3\frac{1}{4}$ "

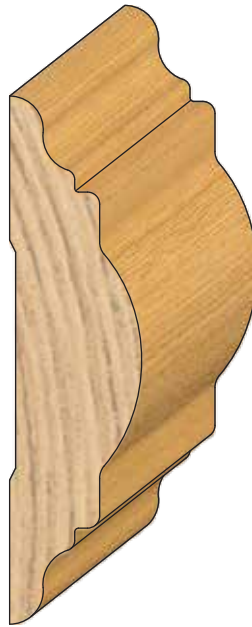

PROFILE # DIMENSION
2288CH $1\frac{1}{16}$ " x $2\frac{3}{4}$ "

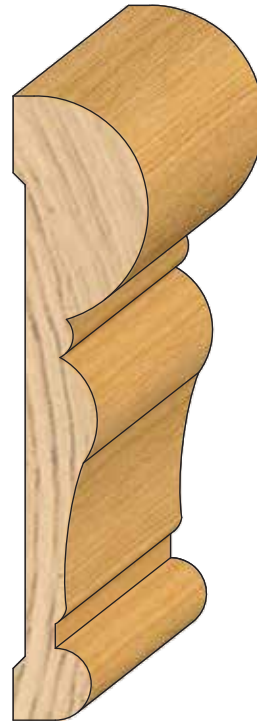

PROFILE # DIMENSION
22104CH $1\frac{1}{16}$ " x $3\frac{1}{4}$ "

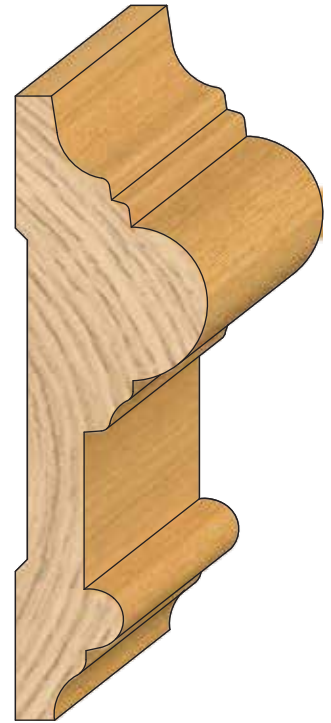

PROFILE # DIMENSION
32104CH 1" x $3\frac{1}{4}$ "

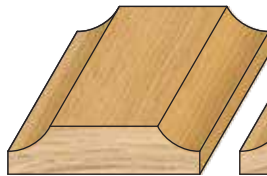

PROFILE # DIMENSION
0832M $\frac{1}{4}$ " x 1"



PROFILE # DIMENSION
0856M $\frac{1}{4}$ " x $1\frac{3}{4}$ "



PROFILE # DIMENSION
0880M $\frac{1}{4}$ " x $2\frac{1}{2}$ "

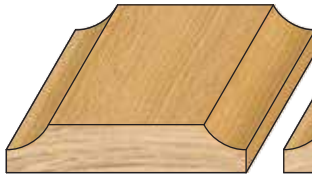

PROFILE # DIMENSION
0840M $\frac{1}{4}$ " x $1\frac{1}{4}$ "



PROFILE # DIMENSION
0864M $\frac{1}{4}$ " x 2"



PROFILE # DIMENSION
0888M $\frac{1}{4}$ " x $2\frac{3}{4}$ "

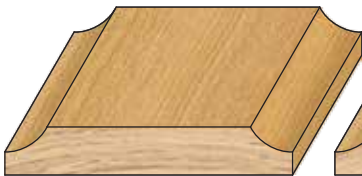

PROFILE # DIMENSION
0848M $\frac{1}{4}$ " x $1\frac{1}{2}$ "



PROFILE # DIMENSION
0872M $\frac{1}{4}$ " x $2\frac{1}{4}$ "



PROFILE # DIMENSION
0896M $\frac{1}{4}$ " x 3"

A variety of wood species are available.

SEE SPECIES CHART ON PAGES 54-58.



WINDOW STOOLS & STOPS

WHOLESALE HARDWOOD INTERIORS, INC.



PROFILE # DIMENSION
1280S 3/8" X 2 1/2"

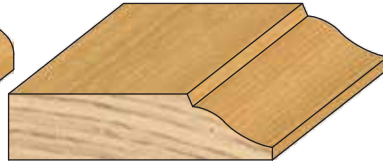

PROFILE # DIMENSION
1144S 1 1/32" X 1 3/8"

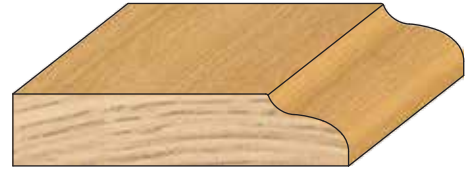

PROFILE # DIMENSION
1256S 3/8" X 1 3/4"



PROFILE # DIMENSION
1296S 3/8" X 3"

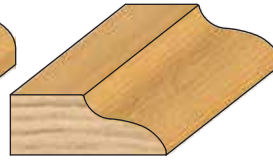

PROFILE # DIMENSION
1026S 5/16" X 1 3/16"



PROFILE # DIMENSION
2472WS 3/4" X 2 1/4"

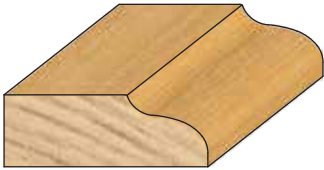

PROFILE # DIMENSION
1234S 3/8" X 1 1/16"



PROFILE # DIMENSION
24168WS 3/4" X 5 1/4"



PROFILE # DIMENSION
40104WS 1 1/4" X 3 1/4"



PROFILE # DIMENSION
40104WS-NR 1 1/4" X 3 1/4"



PROFILE # DIMENSION
2472WSA 3/4" X 2 1/4"



PROFILE # DIMENSION
24136WS 3/4" X 4 1/4"

Images shown are displayed to full scale.

MINIMAL DIFFERENCES MAY APPEAR IN SCALED IMAGES.

PANEL & BED MOULDINGS



ARCHITECTURAL MOULDINGS & MILLWORK



PROFILE # DIMENSION
1840BM $9/16" \times 1 1/4"$



PROFILE # DIMENSION
1846BM $9/16" \times 1 7/16"$

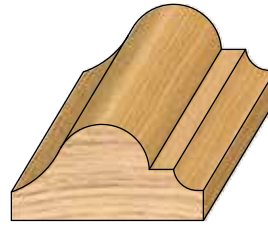

PROFILE # DIMENSION
1632CKPM $1/2" \times 1"$

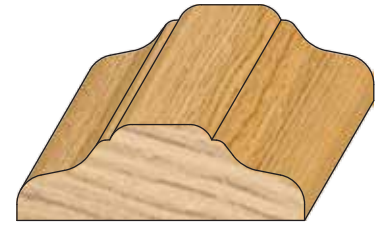

PROFILE # DIMENSION
1648M $1/2" \times 1 1/2"$

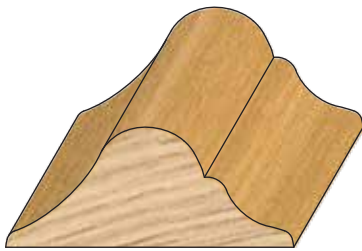

PROFILE # DIMENSION
2048P $5/8" \times 1 1/2"$



PROFILE # DIMENSION
2424PR $3/4" \times 3/4"$
* $1/4" \times 1/2"$ RABBET.

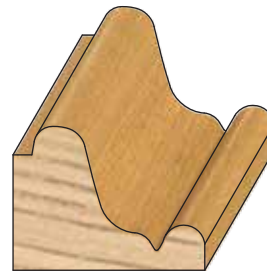

PROFILE # DIMENSION
2432PM $3/4" \times 1"$

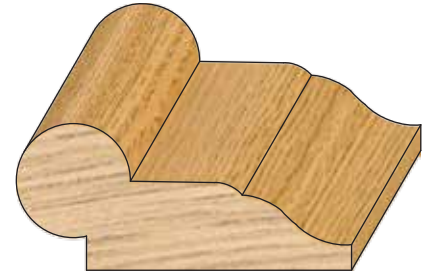

PROFILE # DIMENSION
2456PM $3/4" \times 1 3/4"$

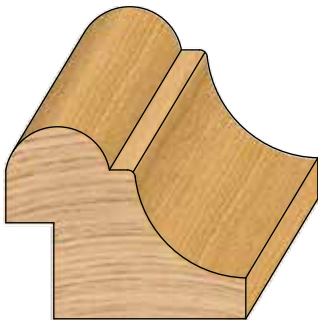

PROFILE # DIMENSION
3240PR $1" \times 1 1/4"$
* $1/4" \times 1/2"$ RABBET.

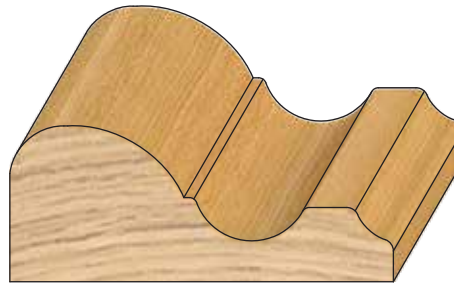

PROFILE # DIMENSION
2664P $1 3/16" \times 2"$



PROFILE # DIMENSION
2664PR $1 3/16" \times 2"$
* $1/2" \times 1/2"$ RABBET.

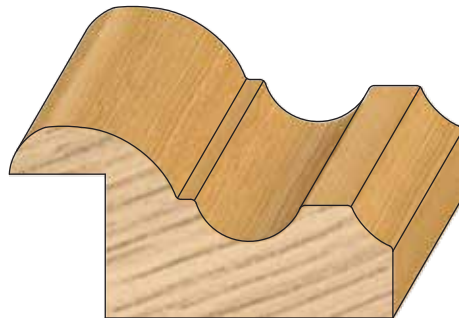

PROFILE # DIMENSION
3264PR $1" \times 2"$
* $1/2" \times 3/4"$ RABBET.

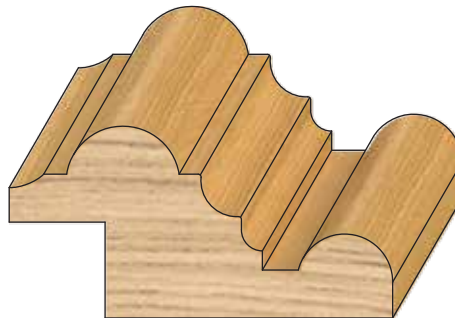

PROFILE # DIMENSION
3264PRJ $1" \times 2"$
* $1/2" \times 1/2"$ RABBET.

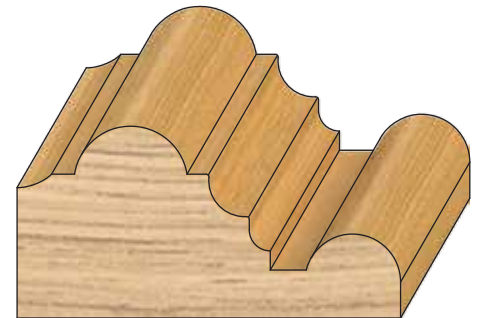

PROFILE # DIMENSION
3264PJ $1" \times 2"$

A variety of wood species are available.

SEE SPECIES CHART ON PAGES 54-58.



PANEL & BED MOULDINGS

WHOLESALE HARDWOOD INTERIORS, INC.

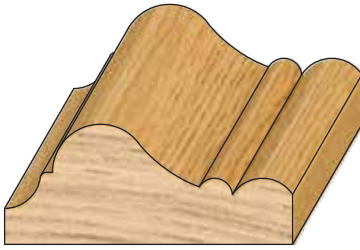

PROFILE #	DIMENSION
2048KWPM	5/8" X 1 1/2"



PROFILE #	DIMENSION
1242BM	3/8" X 1 5/16"

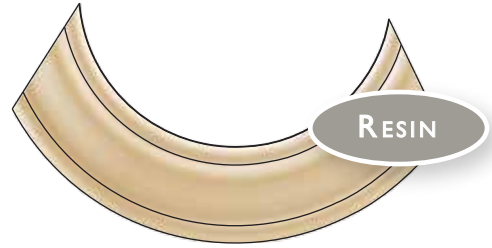

PROFILE #	DIMENSION
U-589-IC	3/8" X 1 5/16"

* MADE FOR INSIDE CORNERS.
 * SHARES SAME PROFILE AS 1242BM.
 * IMAGE NOT DRAWN TO FULL SCALE.
 * RESIN PRODUCTS ARE PAINT-GRADE ONLY.

TRIM MOULDINGS

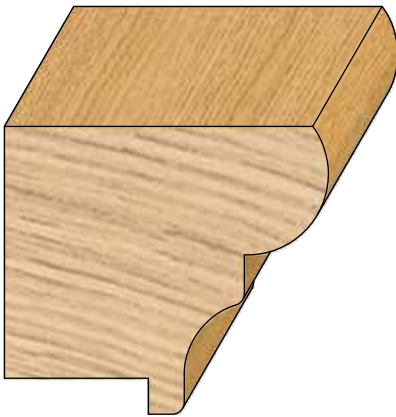

PROFILE #	DIMENSION
5448CM	1 11/16" X 1 1/2" * 3/16" X 3/4" RABBET.



PROFILE #	DIMENSION
624	3/16" X 3/4"



PROFILE #	DIMENSION
1224T	3/8" X 3/4"



PROFILE #	DIMENSION
1212Q	3/8" X 3/8"



PROFILE #	DIMENSION
1416OS	7/16" X 1/2"



PROFILE #	DIMENSION
1416GB	7/16" X 1/2"



PROFILE #	DIMENSION
816	1/4" X 1/2"

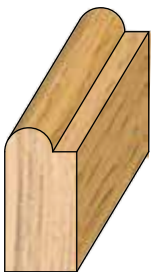

PROFILE #	DIMENSION
1224KR	3/8" X 3/4"



PROFILE #	DIMENSION
2323B	23/32" X 23/32"



PROFILE #	DIMENSION
1624A	1/2" X 3/4"



PROFILE #	DIMENSION
1624R18	1/2" X 3/4"

Images shown are displayed to full scale.

MINIMAL DIFFERENCES MAY APPEAR IN SCALED IMAGES.

TRIM MOULDINGS



ARCHITECTURAL MOULDINGS & MILLWORK



PROFILE # DIMENSION
1624 1/2" X 3/4"

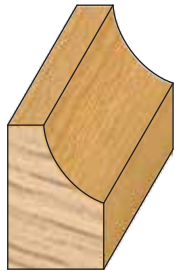

PROFILE # DIMENSION
1624C 1/2" X 3/4"



PROFILE # DIMENSION
1640A 1/2" X 1 1/4"



PROFILE # DIMENSION
1640BN 1/2" X 1 1/4"



PROFILE # DIMENSION
1640-2RE116 1/2" X 1 1/4"



PROFILE # DIMENSION
2024SC 5/8" X 3/4"

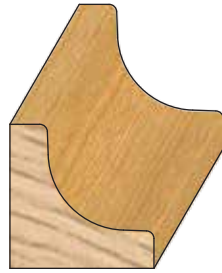

PROFILE # DIMENSION
2424C 3/4" X 3/4"



PROFILE # DIMENSION
2424IC 3/4" X 3/4"

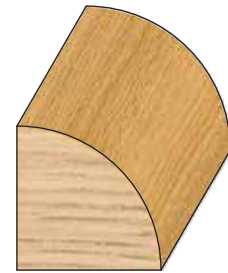

PROFILE # DIMENSION
2424Q 3/4" X 3/4"

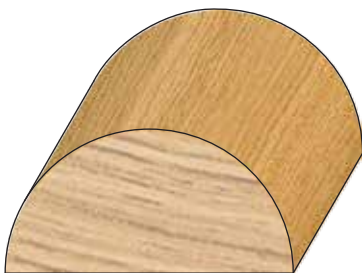

PROFILE # DIMENSION
2448HR 3/4" X 1 1/2"



PROFILE # DIMENSION
2424OC 3/4" X 3/4"

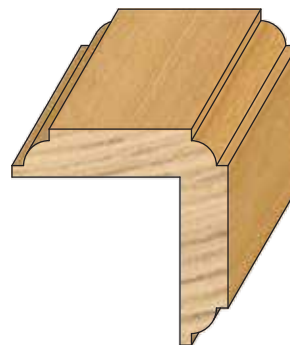

PROFILE # DIMENSION
3636OC 1 1/8" X 1 1/8"



PROFILE # DIMENSION
4040ROD 1 1/4" DIA.

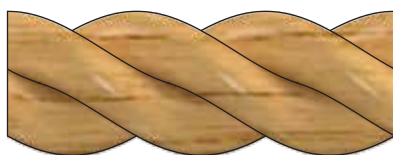
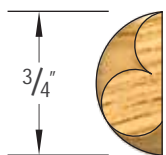

PROFILE # DIMENSION
1124ROPE 1 1/32" X 3/4"

* SOLD IN 96" PIECES.

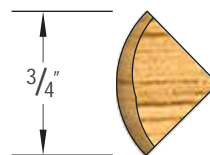

PROFILE # DIMENSION
1724ROPE 17/32" X 3/4"

* NOT A STOCK ITEM, BUT AVAILABLE FOR ORDER AND DELIVERY.
* SOLD IN 96" PIECES.

A variety of wood species are available.

SEE SPECIES CHART ON PAGES 54-58.



Custom Millwork

Wholesale Hardwood Interiors prides itself in making your dreams a reality. Our custom millwork department is hard at work creating a variety of specialty items. Whether it is a photograph you provide or a computer-aided design we produce, we are ready to take on your project.

Your account executive along with our design team will help you create the beautiful look you are imagining. Commercial or residential, our commitment is high quality detailed workmanship.

- Hand-crafted fireplace mantels and book casings.
- Home entertainment cabinetry and cabinet doors.
- Office hardwoods and coffered ceilings.
- Colonial arched jambs, doorways, and curved mouldings.
- Interior pediment headers and custom transoms.
- Decorative accent walls and ceilings.



If you can dream it, we can create it.





BAR RAILS & MANTEL MOULDING

WHOLESALE HARDWOOD INTERIORS, INC.

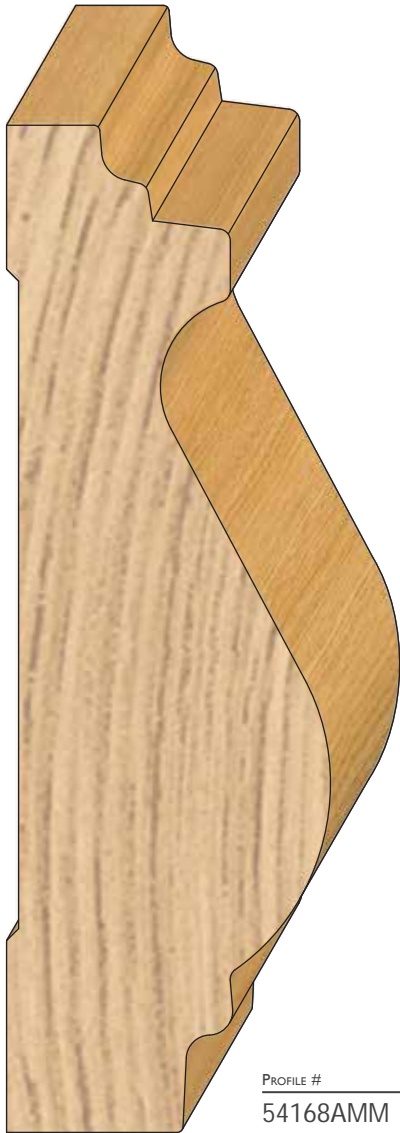

PROFILE # 54168AMM DIMENSION 1 11/16" x 5 1/4"

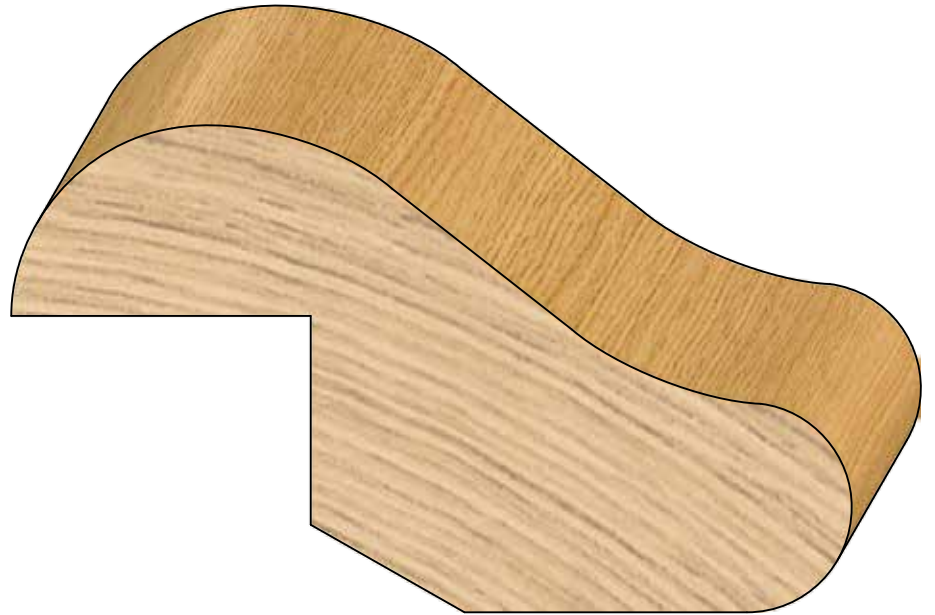

PROFILE # 56144BAR DIMENSION 1 3/4" x 4 1/2"



PROFILE # 4096BAR DIMENSION 1 1/4" x 3"

BAR RAILS

PROFILE #	PAGE #	DIMENSION	POPLAR	RAW FINGER JOINTED POPLAR	PRIMED FINGER JOINTED POPLAR	OAK	PRIMED FINGER JOINTED PINE	PRIMED MDF
4096BAR	32	1 1/4" x 3"	POP			OAK		
56144BAR	32	1 3/4" x 4 1/2"	POP			OAK		

MANTEL MOULDING

PROFILE #	PAGE #	DIMENSION	POPLAR	RAW FINGER JOINTED POPLAR	PRIMED FINGER JOINTED POPLAR	OAK	PRIMED FINGER JOINTED PINE	PRIMED MDF
54168AMM	32	1 11/16" x 5 1/4"	POP					

Images shown are displayed to full scale.

MINIMAL DIFFERENCES MAY APPEAR IN SCALED IMAGES.

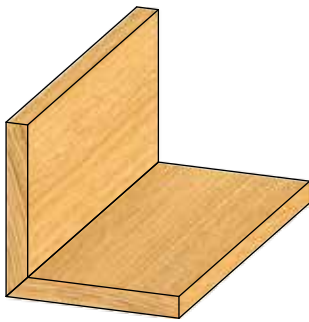

PRODUCT DESCRIPTION

2-Sided

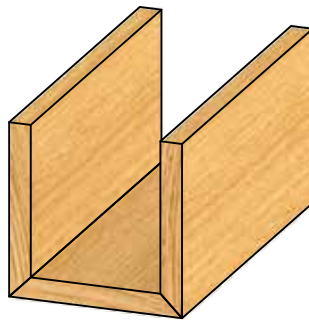

PRODUCT DESCRIPTION

3-Sided

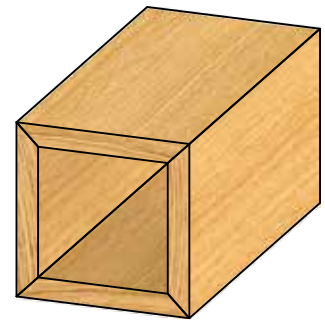

PRODUCT DESCRIPTION

4-Sided

FEATURES

- Widths up to 11-1/4" and lengths up to 16' based on species selection. Longer lengths are available with joinery.
- Configurations include 2, 3 & 4-sided.
- Miter or Butt-Joint assembly available.
- Butt-Jointed corners traditionally assembled with 1/8" to 1/4" reveal depending on specification.

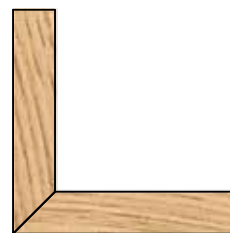

PRODUCT DESCRIPTION

Mitered Corner

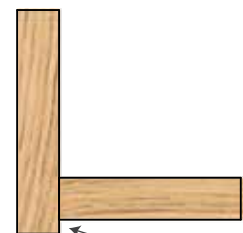

PRODUCT DESCRIPTION

Butt-Jointed Corner



S4S LUMBER

WHOLESALE HARDWOOD INTERIORS, INC.

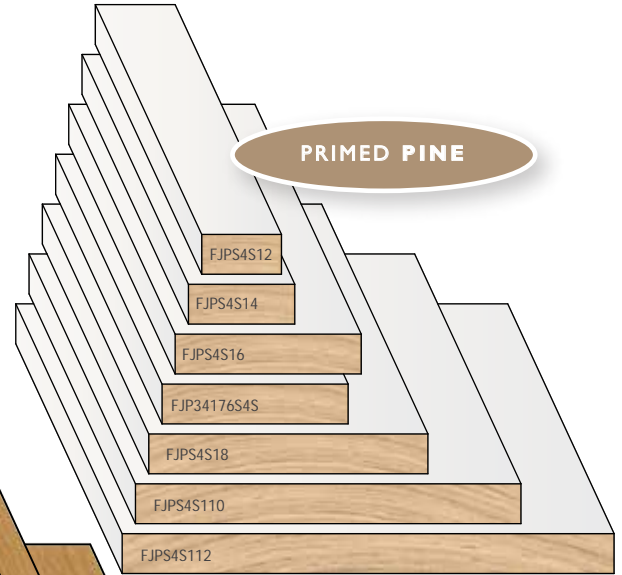
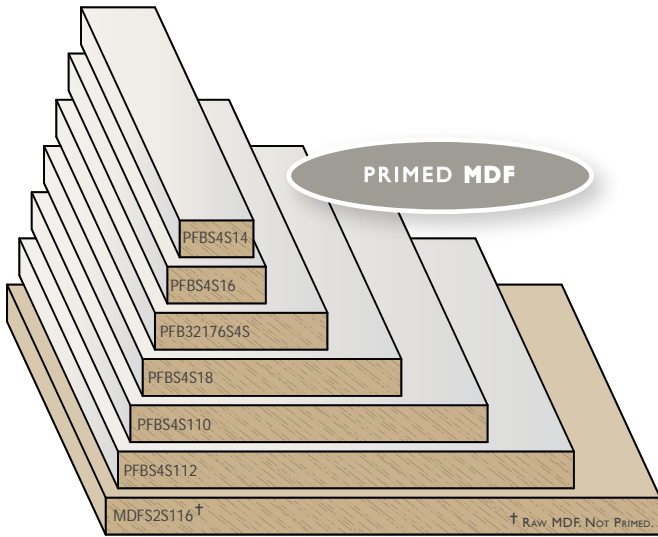

S4S
PROFILES ARE
NOT DRAWN TO
FULL SCALE

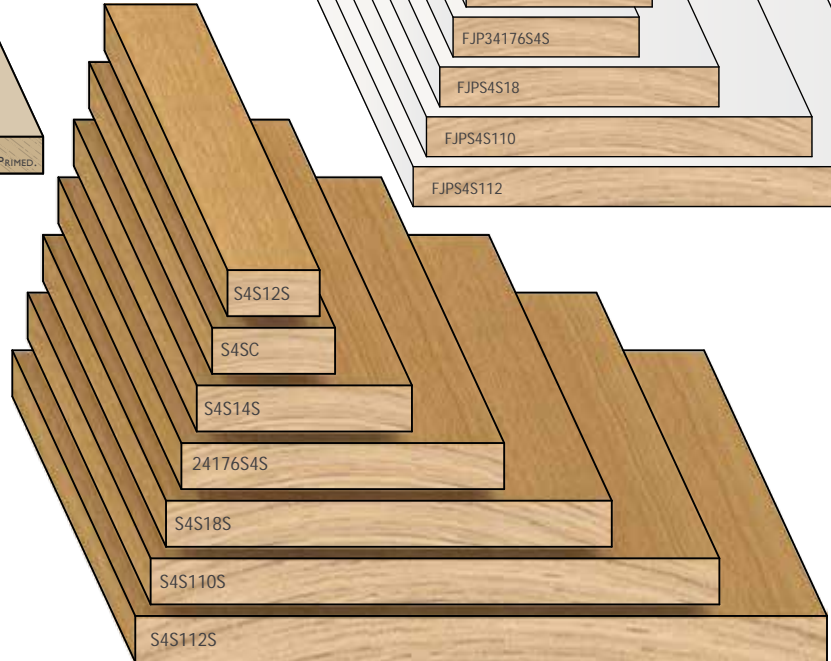

S4S Lumber Species Chart

PROFILE #	PAGE #	DIMENSION	POPLAR	RAW FINGER JOINTED POPLAR	PRIMED FINGER JOINTED POPLAR	OAK	PRIMED FINGER JOINTED PINE	PRIMED MDF
S4S12S	34	3/4" x 1 1/2"	POP	RFJ		OAK		
FJPS4S12	34	23/32" x 1 1/2"					FJP	
S4SC	34	3/4" x 2"	POP	RFJ		OAK		
S4S14S	9, 34	3/4" x 3 1/2"	POP	RFJ		OAK		
PFBS4S14	34	3/4" x 3 1/2"						PFB
FJPS4S14	34	23/32" x 3 1/2"					FJP	
24176S4S	9, 34	3/4" x 5 1/4"	POP	RFJ		OAK		
S4S16SFJP	34	3/4" x 5 1/2"			PFJ			
PFBS4S16	34	3/4" x 5 1/2"						PFB
FJPS4S16	34	23/32" x 5 1/2"					FJP	
FJP34176S4S	34	1 1/16" x 5 1/2"					FJP	
PFB32176S4S	34	1" x 5 1/2"						PFB
S4S18S	34	3/4" x 7 1/4"	POP	RFJ	PFJ	OAK		
PFBS4S18	34	3/4" x 7 1/4"						PFB
FJPS4S18	34	23/32" x 7 1/4"					FJP	
S4S110S	34	3/4" x 9 1/4"	POP		PFJ	OAK		
PFBS4S110	34	3/4" x 9 1/4"						PFB
FJPS4S110	34	23/32" x 9 1/4"					FJP	
S4S112S	34	3/4" x 11 1/4"	POP	RFJ	PFJ	OAK		
PFBS4S112	34	3/4" x 11 1/4"						PFB
FJPS4S112	34	23/32" x 11 1/4"					FJP	

† MDFS2S116

34

3/4" x 15 1/4"

† Raw MDF. Not Primed.

TONGUE & GROOVE

ARCHITECTURAL MOULDINGS & MILLWORK

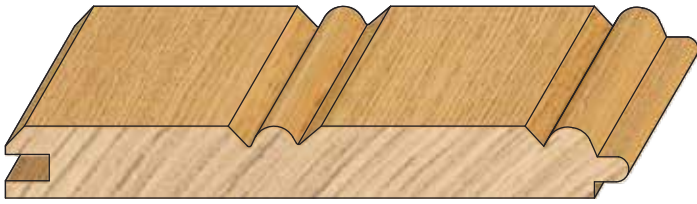

PROFILE # DIMENSION
1296TVGBD $\frac{3}{8}'' \times 3''$ (FACE)

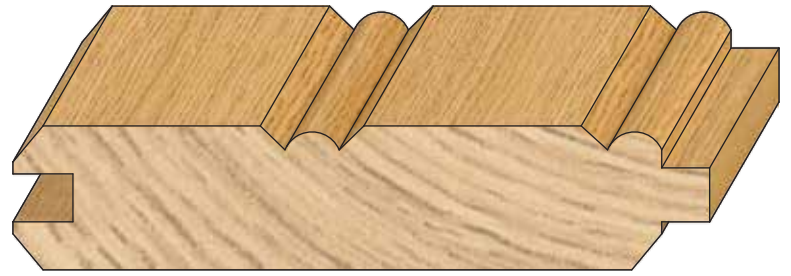

PROFILE # DIMENSION
24108TVGBD $\frac{3}{4}'' \times 3\frac{3}{8}''$ (FACE)
* THIS PRODUCT IS REVERSIBLE.

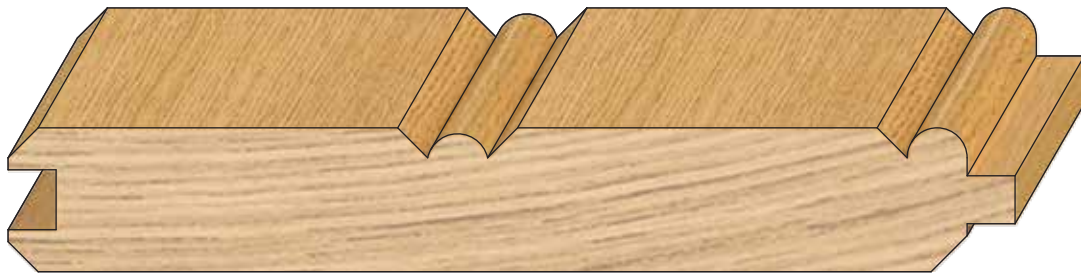

PROFILE # DIMENSION
24160TVGBD $\frac{3}{4}'' \times 5''$ (FACE)
* THIS PRODUCT IS REVERSIBLE.



PROFILE # DIMENSION
2496TVG $\frac{3}{4}'' \times 3''$ (FACE)



PROFILE # DIMENSION
24128TVG $\frac{3}{4}'' \times 4''$ (FACE)

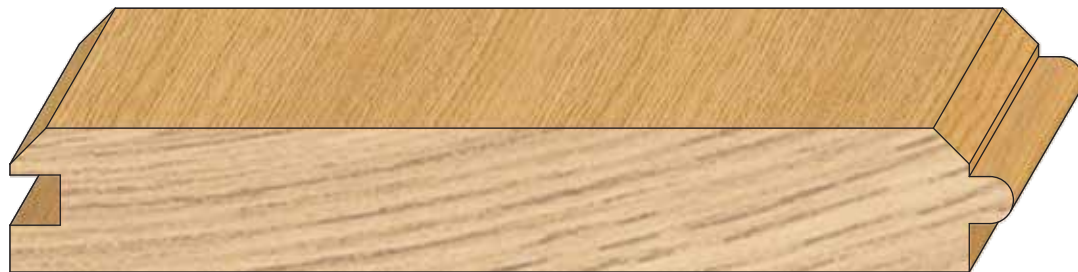

PROFILE # DIMENSION
24160TVG $\frac{3}{4}'' \times 5''$ (FACE)

A variety of wood species are available.

SEE SPECIES CHART ON PAGES 54-58.





PROFILE #	DIMENSION
24168SL18	3/4" x 5 1/4"
* 4 3/4" FACE, 1/8" GAP	

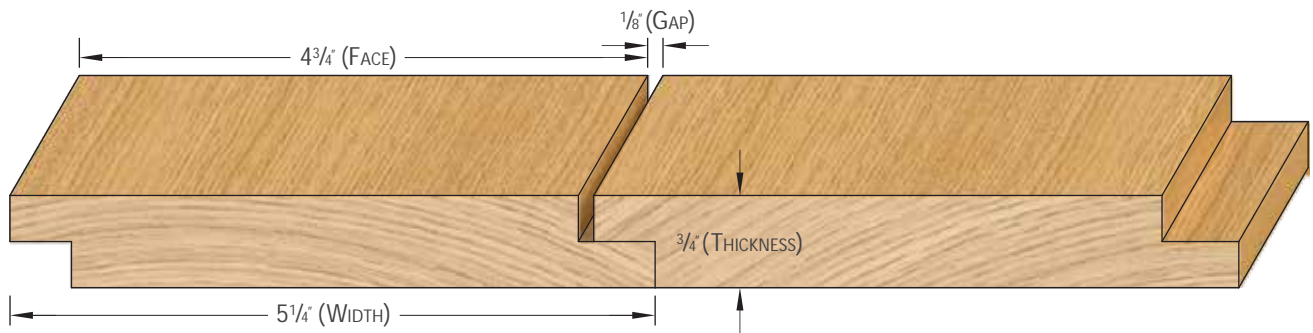

PROFILE #	DIMENSION
24232SL18	3/4" x 7 1/4"
* 6 3/4" FACE, 1/8" GAP	

* NOT A STOCK ITEM, BUT AVAILABLE FOR ORDER AND DELIVERY.

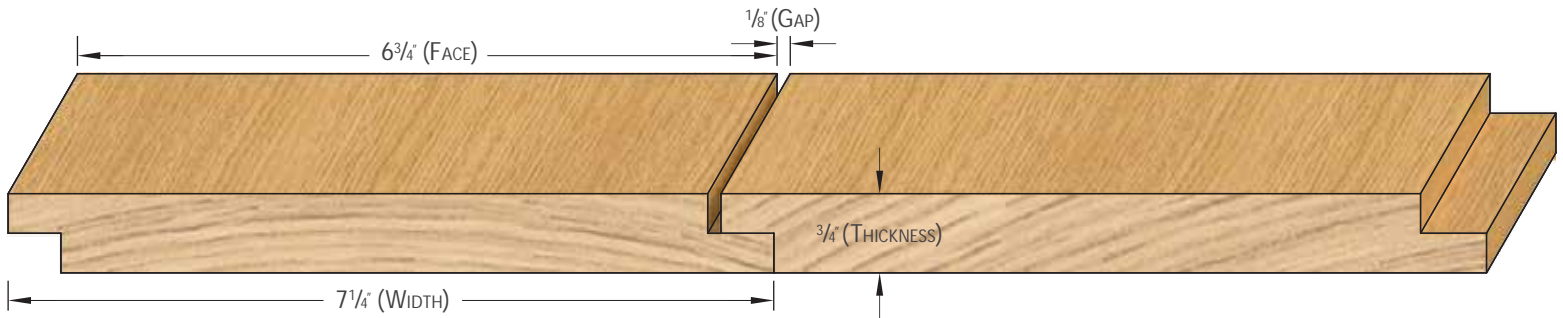

A variety of wood species are available.

SEE SPECIES CHART ON PAGES 54-58.



ARCHED JAMBS INFORMATION

WHOLESALE HARDWOOD INTERIORS, INC.

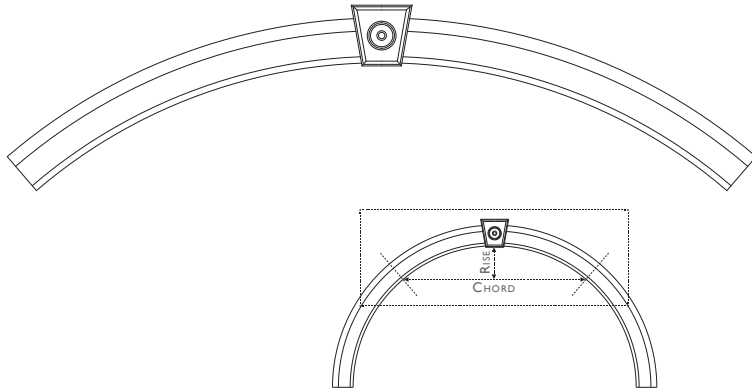

EYELID ARCH

The Eyelid Arch is a segment of a True Half Circle. When calculating measurements for this arch include the following:

1. The chord.
2. The rise.
3. Special instructions.

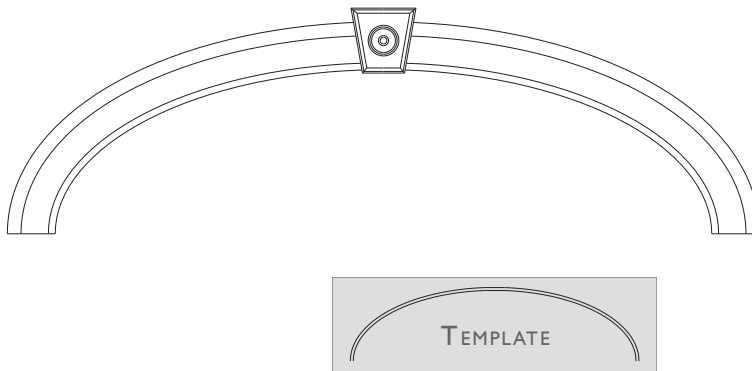

ELLIPTICAL ARCH

The Elliptical Arch is a combination of at least two radii. When calculating measurements for this arch include the following:

1. Template is required.

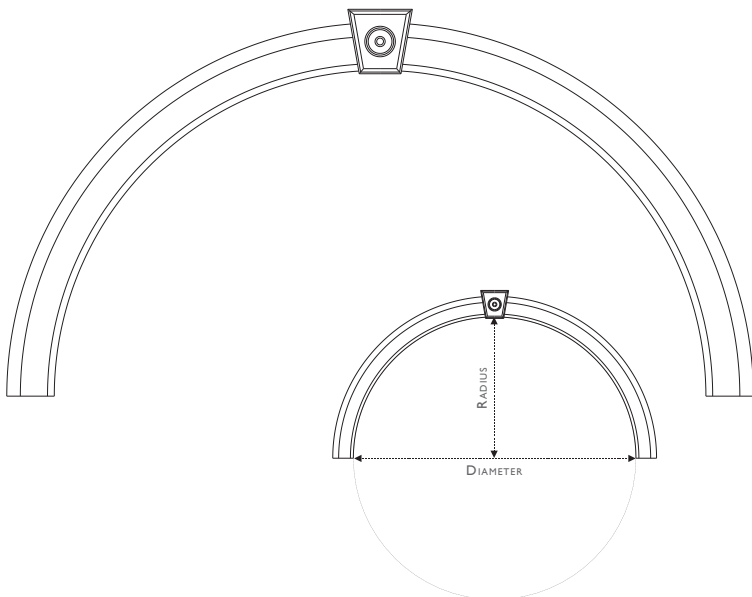

TRUE HALF CIRCLE ARCH

The True Half Circle Arch is as its name describes, a true half circle. When calculating measurements for this arch include the following:

1. The diameter.
2. The radius.
3. Special instructions.



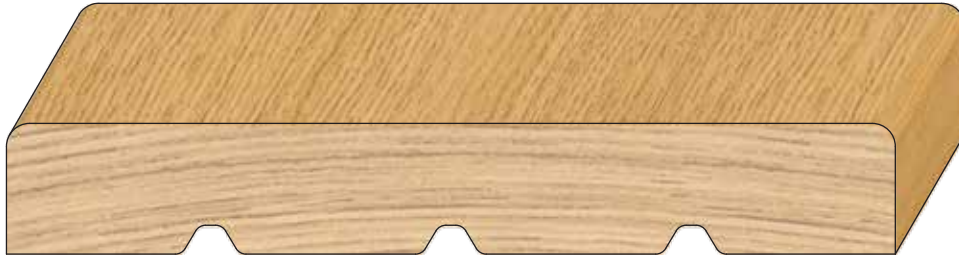

PRODUCT DESCRIPTION

Flat Jambs

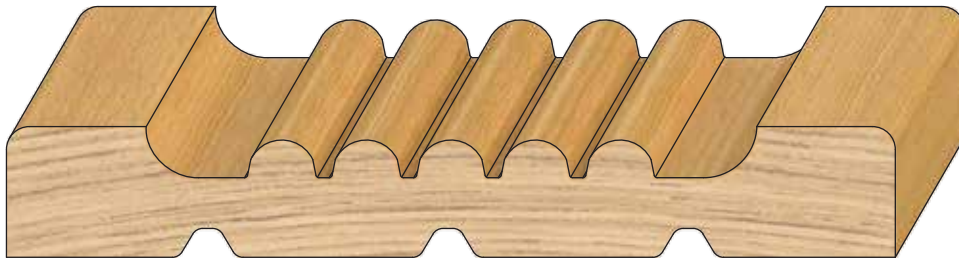

PRODUCT DESCRIPTION

Reeded Jambs

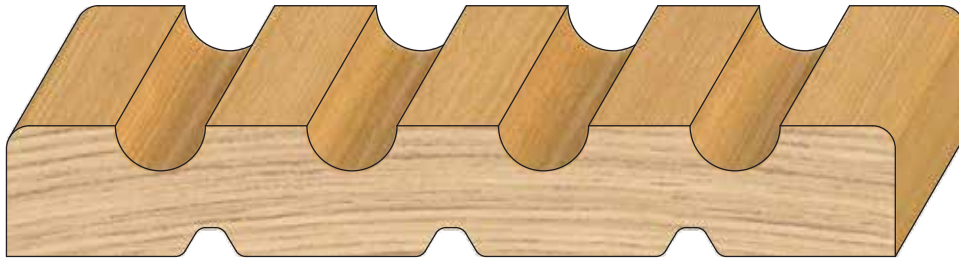

PRODUCT DESCRIPTION

Fluted Jambs

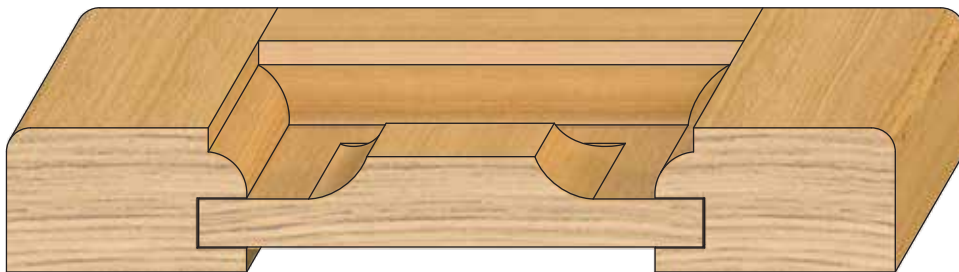

PRODUCT DESCRIPTION

Raised Panel Jambs

A variety of wood species are available.

CALL OR CONTACT YOUR ACCOUNT EXECUTIVE FOR DETAILS.



THE ADVANTAGE OF PRIMED MDF

Being *MADE IN AMERICA* utilizes a domestic supply chain which provides the high level of responsiveness required to be successful in today's ever-changing market. Not only does domestic sourcing provide faster response times and more opportunity for customization specific to your needs, but it also promotes job growth and community development right here in the USA!

INSTALLING PRIMED MDF

- Store mouldings on the jobsite flat, and up off the floor to prevent material from getting wet and drawing moisture.
- Prior to installation, mouldings should be stored in room conditions for a minimum of 48 hours. Contrary to popular belief, MDF can expand and contract due to changes in relative humidity, so acclimation is very important.
- When ripping, cutting or routing, carbide tipped blades and/or cutter heads are strongly recommended.
- Pneumatic fastening systems with the air pressure set at 90 – 120 PSI works best.
- The types of fasteners that work best are 16-18 gauge finish nails. Smooth shank nails are not recommended. However, it is up to the installer to decide what works best for his own application.
- MDF is a man-made product that is excellent for face nailing (1" from ends and ¼" from edges is recommended). Edge nailing is not recommended.
- The use of a fast-drying adhesive, such as our Kwik-Bond Adhesive and Activator, helps to prevent the separation of mitered corners. Another option for applying casing around doors and windows is to use casing corner blocks. In this application, the use of glue is not required.

MEDIUM-DENSITY FIBERBOARD (MDF):
ENGINEERED FROM RECYCLED WOOD PRODUCTS, GLUED AND PRESSED TO GENERATE A PREFERRED BUILDING MATERIAL.

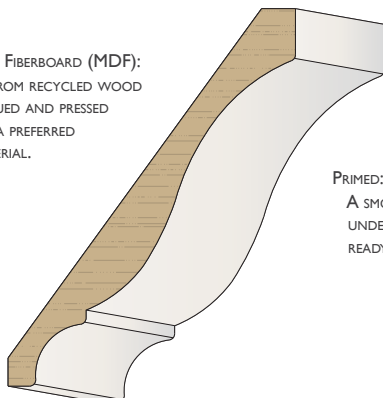

PRIMED:
A SMOOTH PRE-APPLIED UNDERCOAT, EASY AND READY TO PAINT.

FINISHING PRIMED MDF

Wholesale Hardwood Interiors' Primed MDF mouldings are coated with a high-quality water based acrylic latex primer. Any high-quality water, oil, or lacquer based topcoats will work to produce a good finished product. (For best results, follow the paint manufacturer's instructions regarding product use.)

Wholesale Hardwood Interiors' Primed MDF mouldings have an exclusive finish process with a double prime and double profile-sand manufacturing process which results in a smoother finish, decreasing in-field finishing time and associated costs.

FOR BEST RESULTS WITH PRIMED MDF

- Fill and seal all nail holes.
- Lightly sand with fine grit sandpaper or a piece of Scotchbrite.
- Wipe down the surface of the moulding that is going to be painted with a tack cloth to remove any excess dust left from sanding.
- Apply the first coat of premium paint.
- Lightly sand again with fine grit sandpaper or Scotchbrite to help the second coat of paint adhere to the first.
- Wipe down the moulding with a tack cloth to remove any dust from sanding.
- Apply a second coat of premium paint.

PRIMED PINE

In conjunction with Primed MDF, Wholesale Hardwood Interiors offers Primed Pine. Primed Pine allows customers to have an alternate wood option that is primed and ready for painting.

* SEE PAGES 48-53 FOR PRIMED PINE PROFILES.



CASINGS

PRIMED MDF

WHOLESALE HARDWOOD INTERIORS, INC.

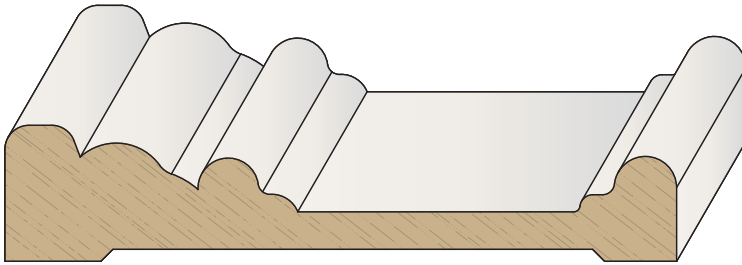

PROFILE # DIMENSION
PFB18M112CA 18mm x 3 1/2"

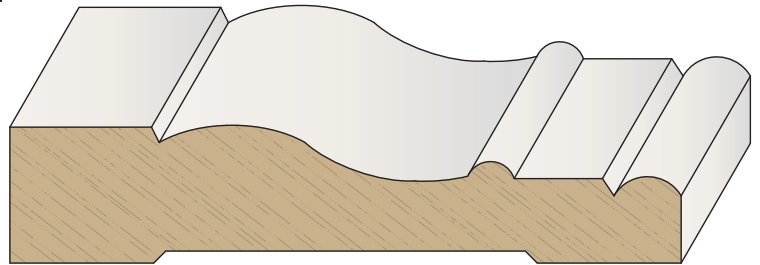

PROFILE # DIMENSION
PFB18M112ULCA 18mm x 3 1/2"

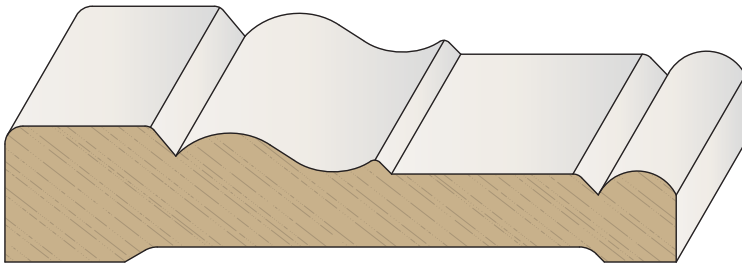

PROFILE # DIMENSION
PFB18M112CCA 18mm x 3 1/2"

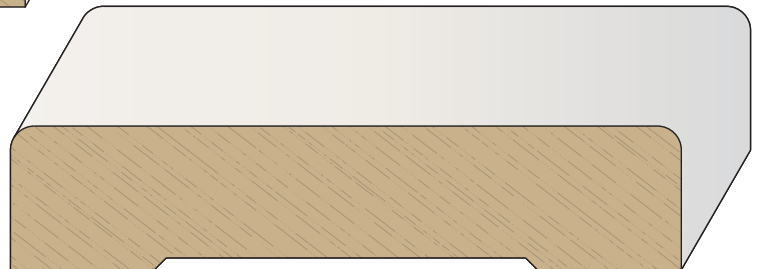

PROFILE # DIMENSION
PFB24112R18CA 3/4" x 3 1/2"

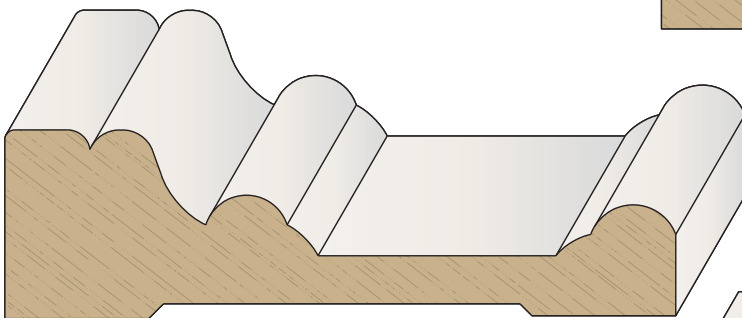

PROFILE # DIMENSION
PFB25M112HCA 25mm x 3 1/2"

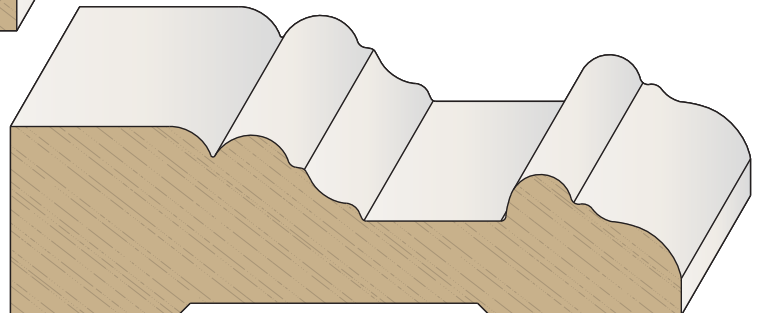

PROFILE # DIMENSION
PFB25M112CA 25mm x 3 1/2"

Images shown are displayed to full scale.

MINIMAL DIFFERENCES MAY APPEAR IN SCALED IMAGES.

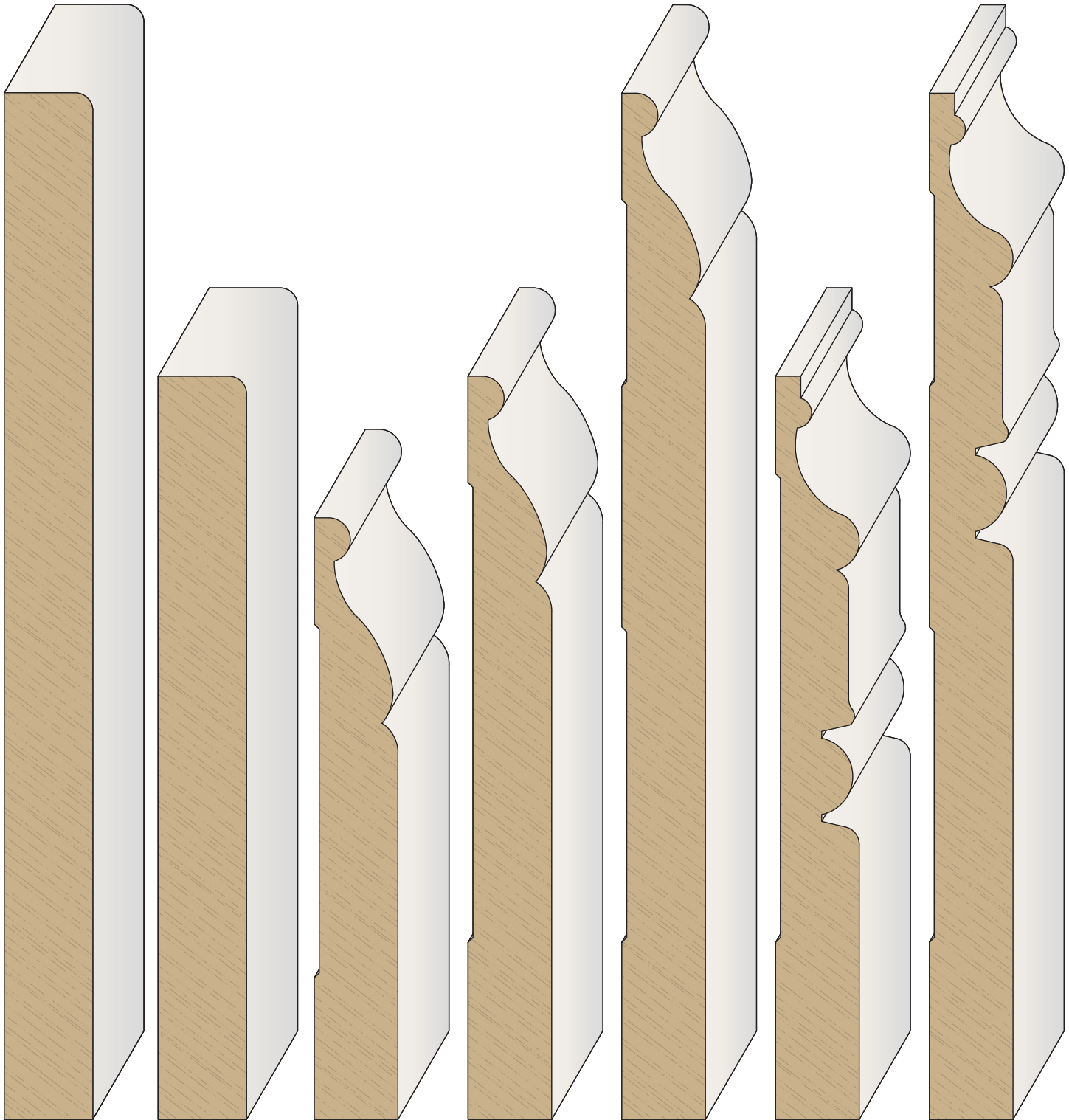

PROFILE #
PFB20232R18B
DIMENSION
5/8" x 7 1/4"

PROFILE #
PFB20168R18B
DIMENSION
5/8" x 5 1/4"

PROFILE #
PFB15M136CB
DIMENSION
15mm x 4 1/4"

PROFILE #
PFB15M168CB
DIMENSION
15mm x 5 1/4"

PROFILE #
PFB15M232CB
DIMENSION
15mm x 7 1/4"

PROFILE #
PFB15M168EB
DIMENSION
15mm x 5 1/4"

PRODUCT SKU
PFB15M232EB
DIMENSION
15mm x 7 1/4"

For installation see Primed MDF Information on page 41.

A VARIETY OF WOOD SPECIES ARE AVAILABLE. SEE SPECIES CHART ON PAGES 54-58.



PROJECTION
 $3\frac{1}{8}"$

PROFILE # DIMENSION
PFB15M168BCR 15mm x $5\frac{1}{4}"$

PROJECTION
 $5\frac{3}{64}"$

HEIGHT
 $4\frac{7}{32}"$

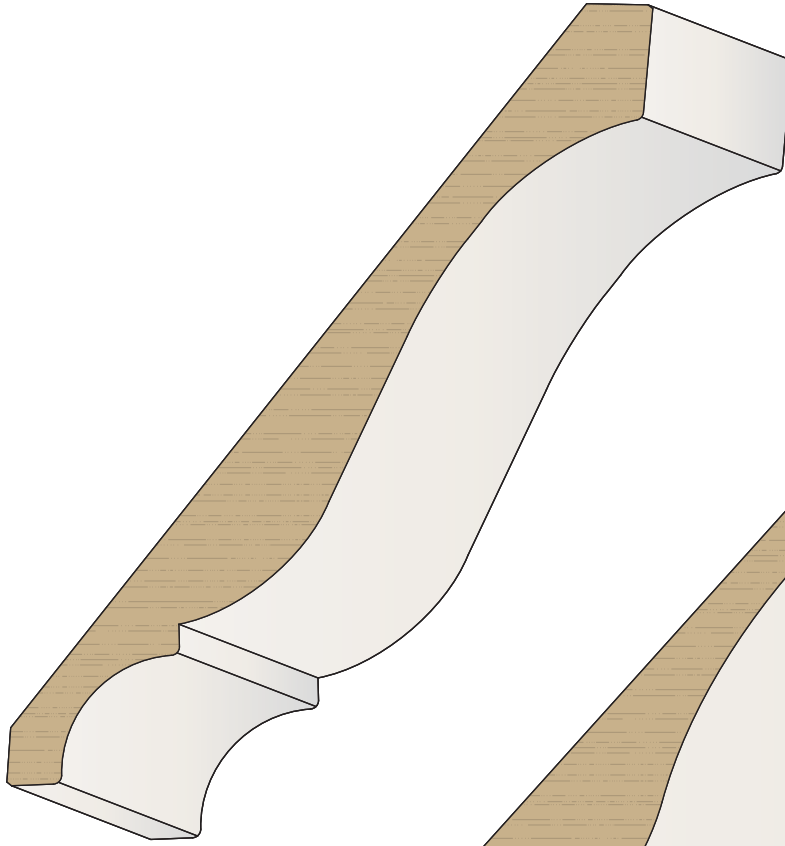

PROJECTION
 $2\frac{7}{16}"$

HEIGHT
 $5\frac{1}{4}"$

PROFILE # DIMENSION
PFB18M232RBBCR 18mm x $7\frac{1}{4}"$

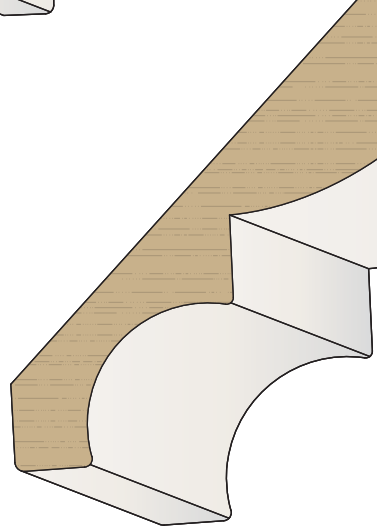

HEIGHT
 $3\frac{15}{32}"$

PROFILE # DIMENSION
PFB15M136BCR 15mm x $4\frac{1}{4}"$

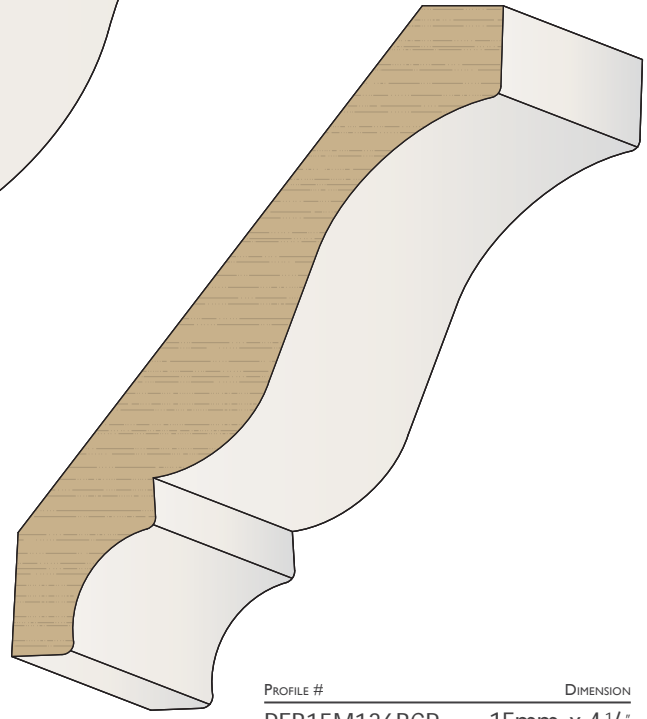

Images shown are displayed to full scale.

MINIMAL DIFFERENCES MAY APPEAR IN SCALED IMAGES.

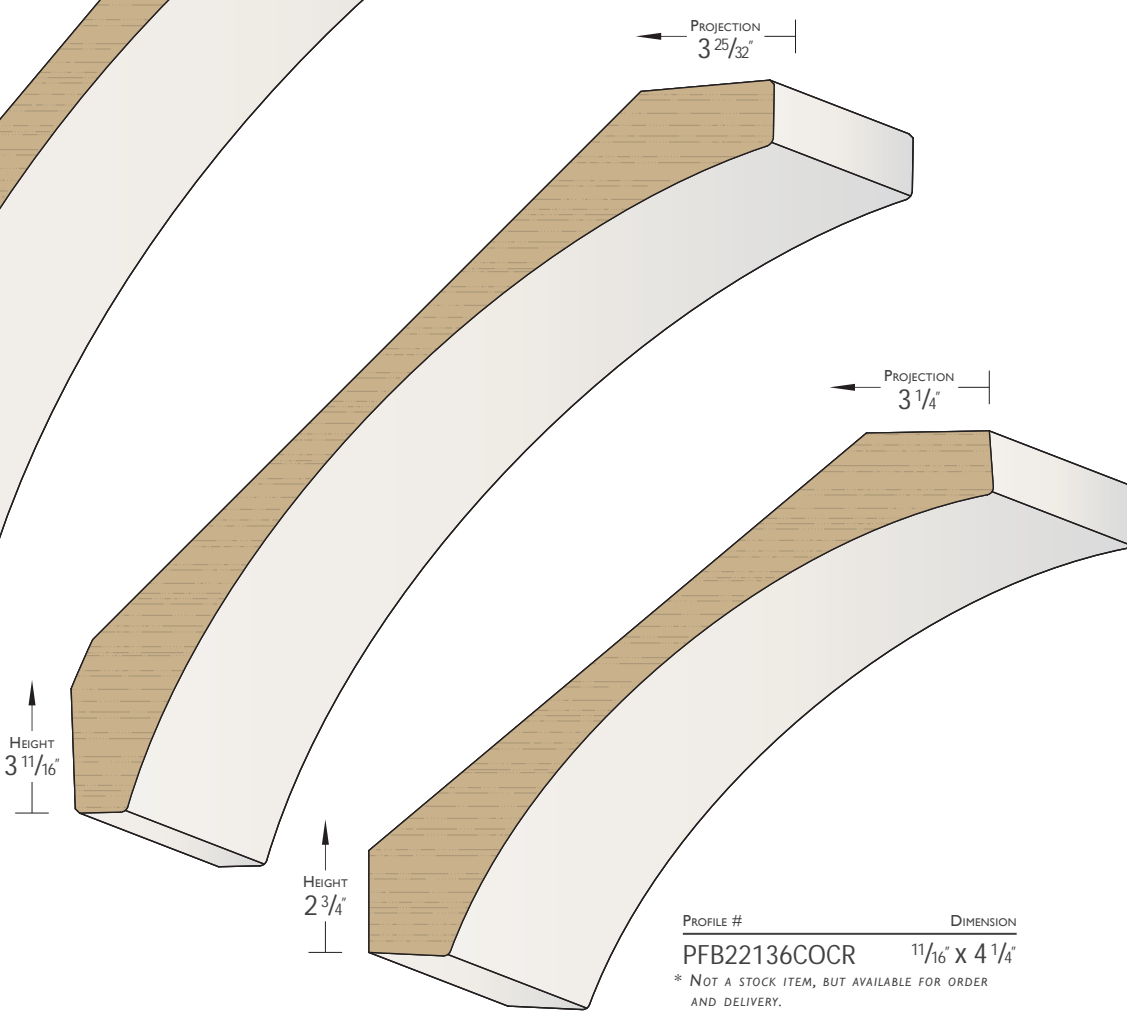
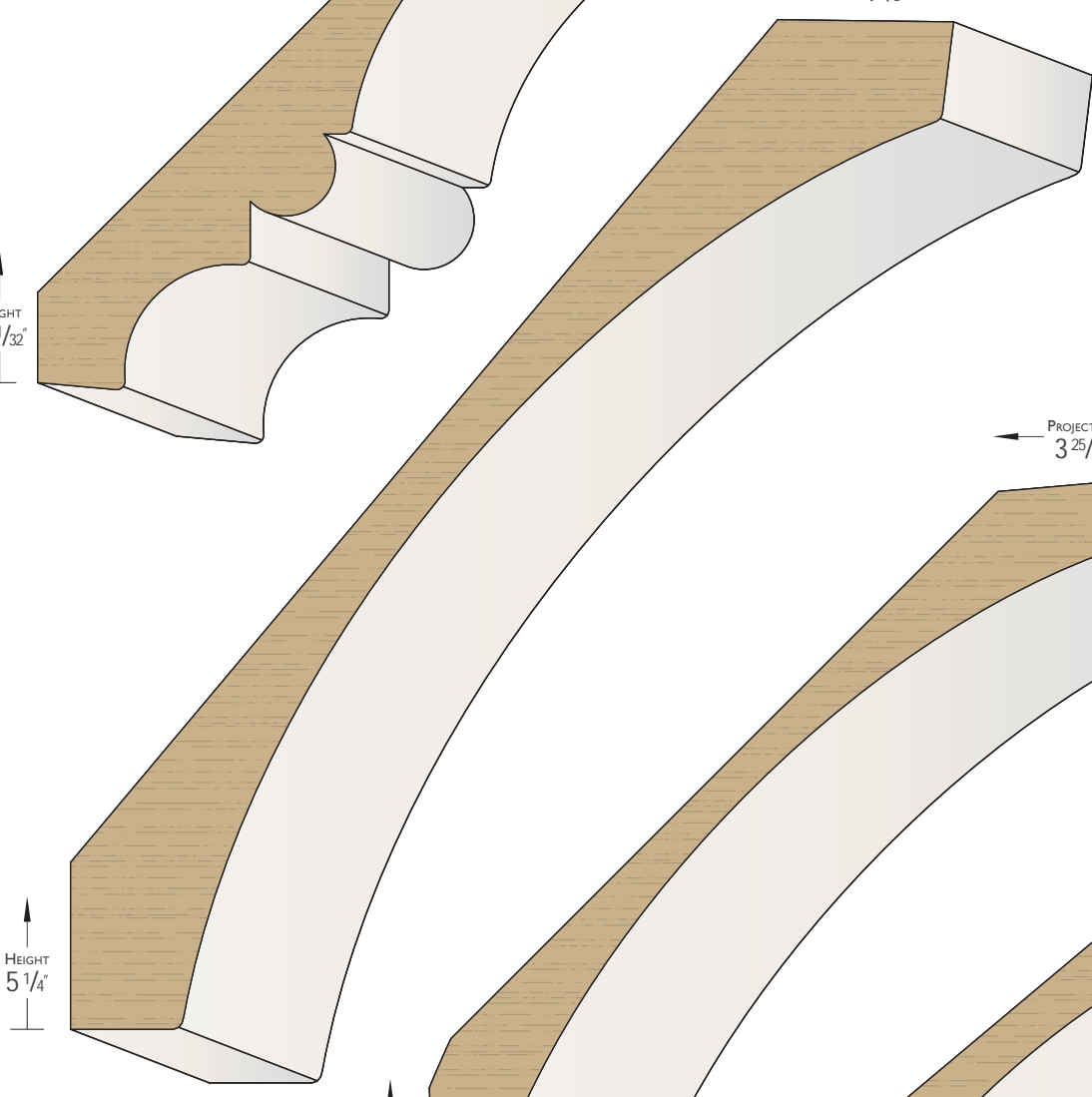
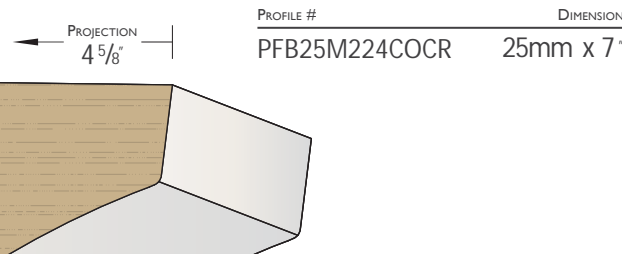
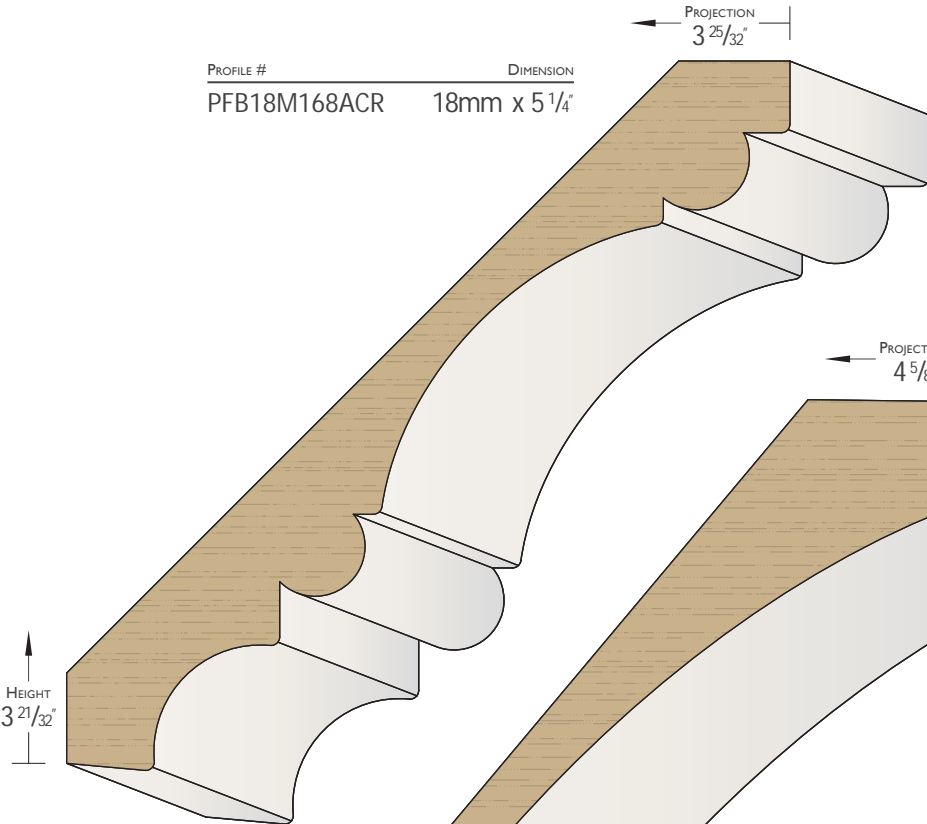

* NOT A STOCK ITEM, BUT AVAILABLE FOR ORDER AND DELIVERY.



CROWNS

PRIMED MDF

WHOLESALE HARDWOOD INTERIORS, INC.

PROFILE #	DIMENSION
PFB18M168CCR	18mm x 5 1/4"

PROJECTION
3 23/32"

PROFILE #	DIMENSION
PFB25M232CCR	25mm x 7 1/4"

PROJECTION
5 3/16"

PROJECTION
5 3/16"

HEIGHT
3 23/32"

HEIGHT
5 3/32"

HEIGHT
5 3/32"

PROJECTION
4 7/16"

PROFILE #	DIMENSION
PFB20M232CR	20mm x 7 1/4"

HEIGHT
4 7/16"

PROFILE #	DIMENSION
PFB25M202OGCR	25mm x 6 5/16"

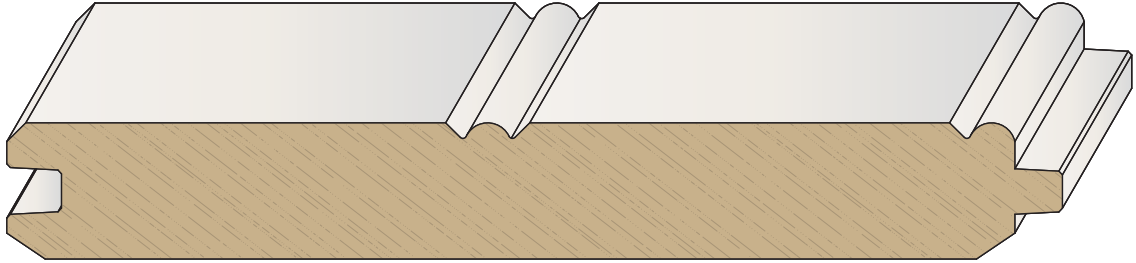

PROFILE # DIMENSION
PFB18M168TVG 18mm x 5 1/4" (FACE)



PROFILE # DIMENSION
PFB24160QRKTAG 3/4" x 5" (FACE)

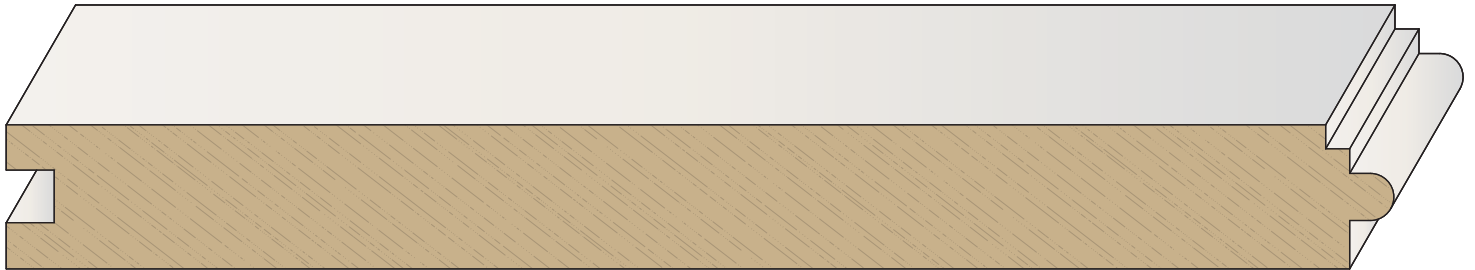

PROFILE # DIMENSION
PFB24224QRKTAG 3/4" x 7" (FACE)

For installation see Primed MDF Information on page 41.

A VARIETY OF WOOD SPECIES ARE AVAILABLE. SEE SPECIES CHART ON PAGES 54-58.



CASINGS

PRIMED PINE

WHOLESALE HARDWOOD INTERIORS, INC.

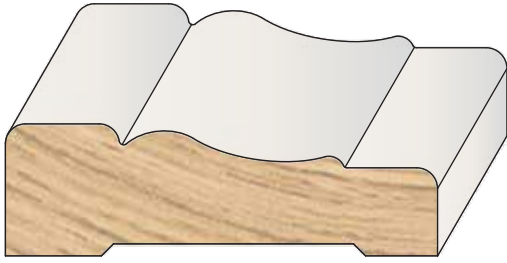

PROFILE # DIMENSION
PFPWM356 1 1/16" x 2 1/4" x 14'

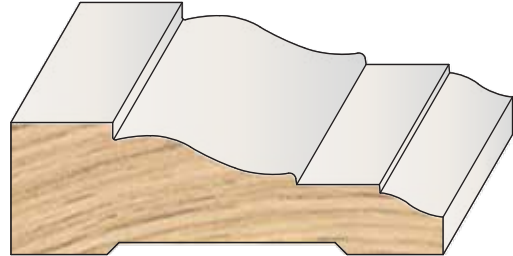

PROFILE # DIMENSION
FJPWM366 1 1/16" x 2 1/4" x 14'

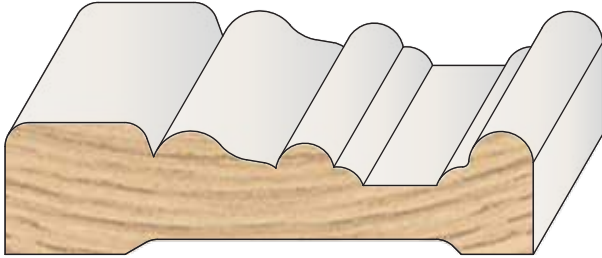

PROFILE # DIMENSION
PFP2288CA 1 1/16" x 2 3/4" x 15'

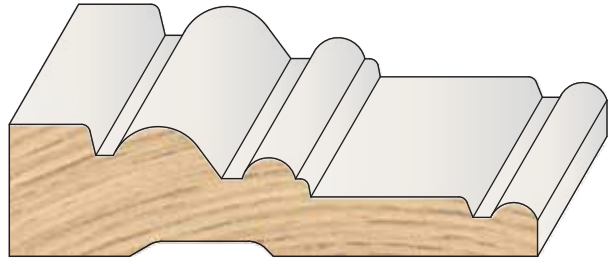

PROFILE # DIMENSION
PFP2288ECA 1 1/16" x 2 3/4" x 15'

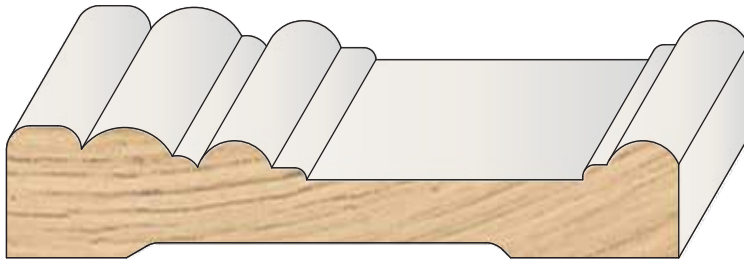

PROFILE # DIMENSION
PFP22112WCA 1 1/16" x 3 1/2" x 15'

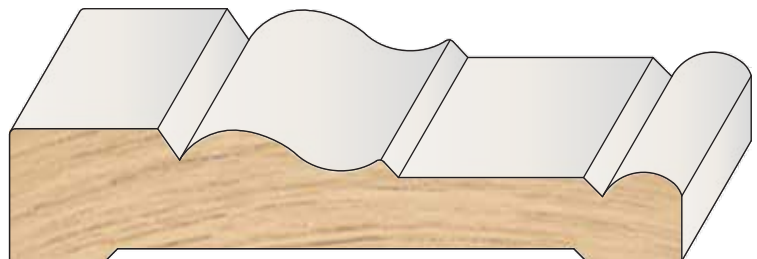

PROFILE # DIMENSION
PFP22112CCA 1 1/16" x 3 1/2" x 15'

Images shown are displayed to full scale.

MINIMAL DIFFERENCES MAY APPEAR IN SCALED IMAGES.

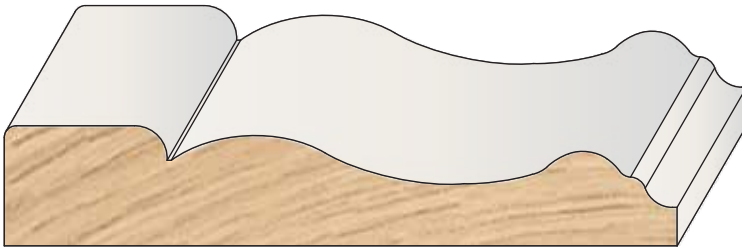

PROFILE # DIMENSION
FJP20112BHCA $5/8" \times 3\ 1/2" \times 15'$

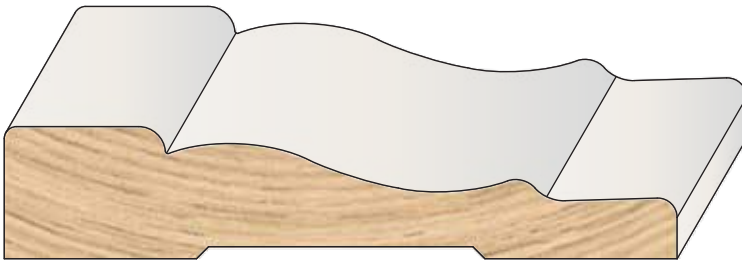

PROFILE # DIMENSION
PFPWM444 $1\ 1/16" \times 3\ 1/2" \times 17'$



PROFILE # DIMENSION
PFP21112R18CA $2\ 1/32" \times 3\ 1/2" \times 15'$



PROFILE #
PFPWM663
 DIMENSION
 $9/16" \times 3\ 1/4" \times 16'$



PROFILE #
PFPWM623
 DIMENSION
 $9/16" \times 3\ 1/4" \times 16'$

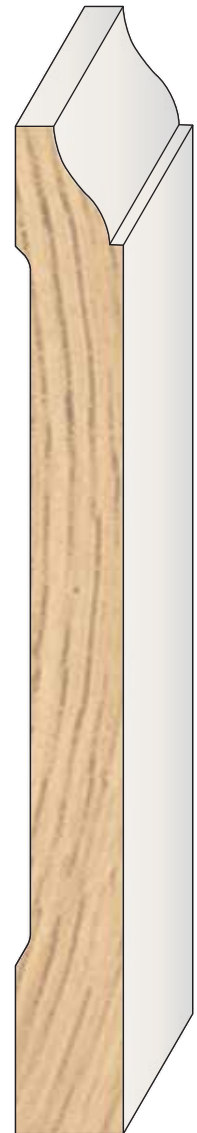

PROFILE #
FJPWM618
 DIMENSION
 $9/16" \times 5\ 1/4" \times 16'$

A variety of wood species are available.

SEE SPECIES CHART ON PAGES 54-58.



BASES & SHOE MOULDINGS

PRIMED PINE

WHOLESALE HARDWOOD INTERIORS, INC.

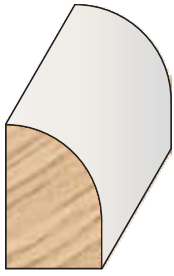

PROFILE # FJP1624A
DIMENSION 1/2" x 3/4"

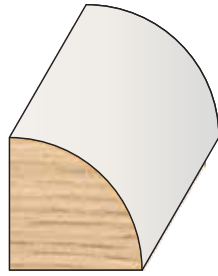

PROFILE # FJP2222Q
DIMENSION 1 1/16" x 1 1/16"



PROFILE # FJP1424R18
DIMENSION 7/16" x 3/4"

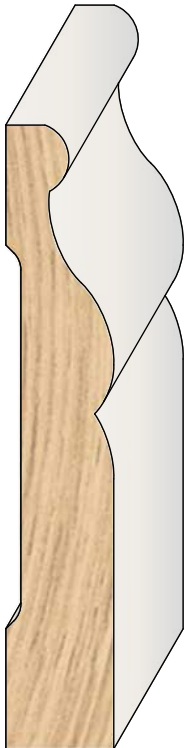

PROFILE # PFP18104CB
DIMENSION 9/16" x 3 1/4" x 16'



PROFILE # PFP18136CB
DIMENSION 9/16" x 4 1/4" x 16'



PROFILE # PFP18168CB
DIMENSION 9/16" x 5 1/4" x 16'

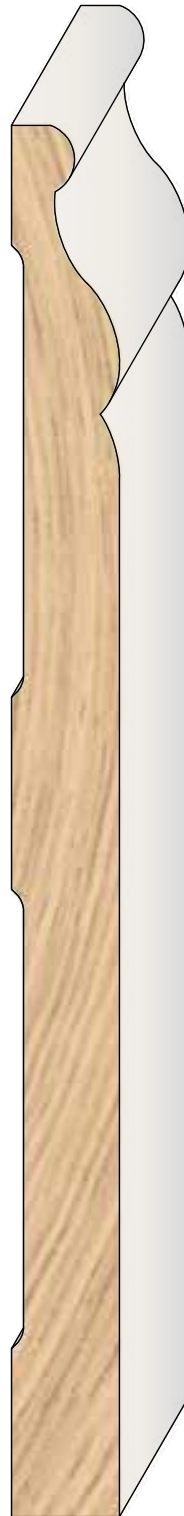

PROFILE # PFP18232CB
DIMENSION 9/16" x 7 1/4" x 16'



PROFILE # PFP17136R18B
DIMENSION 17/32" x 4 1/4" x 16'



PROFILE # PFP17168R18B
DIMENSION 17/32" x 5 1/4" x 16'

Images shown are displayed to full scale.

MINIMAL DIFFERENCES MAY APPEAR IN SCALED IMAGES.



SHIPLAP

PRIMED PINE

WHOLESALE HARDWOOD INTERIORS, INC.



PROFILE #	DIMENSION
PFP18172SL18	$\frac{9}{16}'' \times 5\frac{3}{8}'' \times 16'$ * $4\frac{7}{8}''$ FACE, $\frac{1}{8}''$ GAP

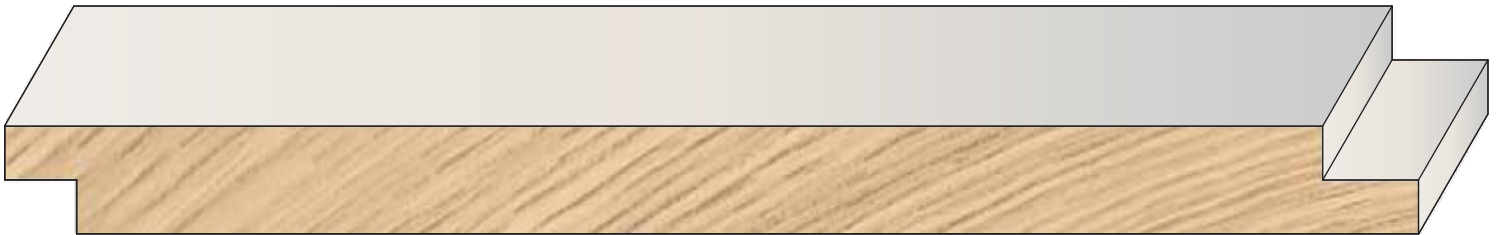
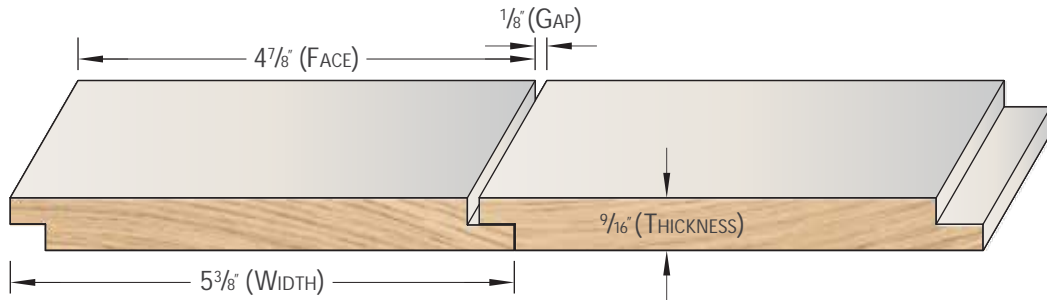

PROFILE #	DIMENSION
PFP18236SL18	$\frac{9}{16}'' \times 7\frac{3}{8}'' \times 16'$ * $6\frac{7}{8}''$ FACE, $\frac{1}{8}''$ GAP

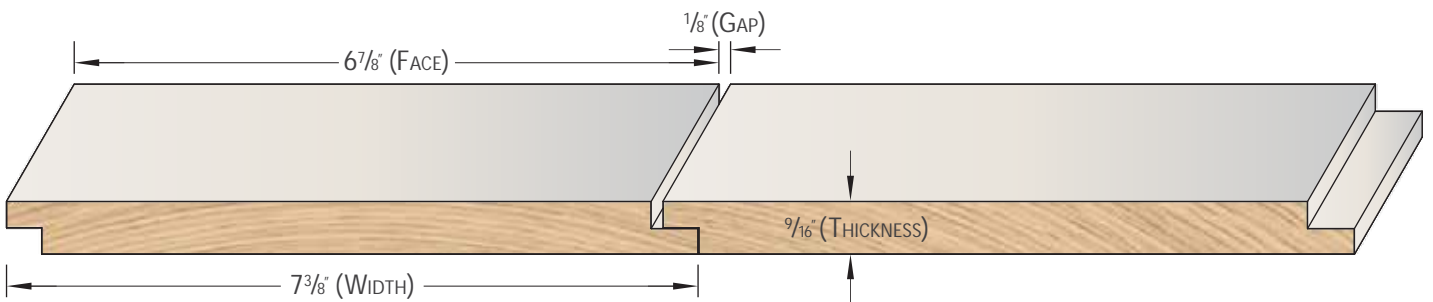

Images shown are displayed to full scale.

MINIMAL DIFFERENCES MAY APPEAR IN SCALED IMAGES.



PROFILE #	DIMENSION
FJP458FLA	$2\frac{1}{32}'' \times 4\frac{5}{8}'' \times 16'$
FJP458FLALGS	$2\frac{1}{32}'' \times 4\frac{5}{8}'' \times 81\frac{21}{32}''$

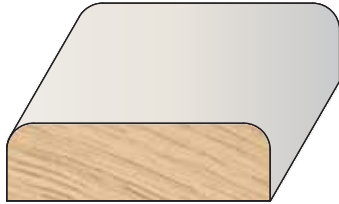

PROFILE #	DIMENSION
FJP1516S68	$1\frac{3}{32}'' \times 1\frac{3}{8}'' \times 81'$





SPECIES CHART

WHOLESALE HARDWOOD INTERIORS, INC.

CASINGS

PROFILE #	PAGE #	DIMENSION	POPLAR	RAW FINGER JOINTED POPLAR	PRIMED FINGER JOINTED POPLAR	OAK	PRIMED FINGER JOINTED PINE	PRIMED MDF
1872CA	2	9/16" x 2 1/4"	POP					
2472CA	2	3/4" x 2 1/4"	POP	RFJ		OAK		
PFPWM356	48	1 1/16" x 2 1/4" x 14'					PFP	
2472BCA	2	3/4" x 2 1/4"	POP	RFJ				
24104HNCA	2	3/4" x 3 1/4"		RFJ				
2488ECA	2	3/4" x 2 3/4"	POP		PFJ			
PFP2288ECA	48	1 1/16" x 2 3/4" x 15'					PFP	
24112CCA	2	3/4" x 3 1/2"	POP		PFJ	OAK		
PFB18M112CCA	42	18mm x 3 1/2"						PFB
PFP22112CCA	48	1 1/16" x 3 1/2" x 15'					PFP	
2472MWCA	3	3/4" x 2 1/4"		RFJ				
24112WCA	3	3/4" x 3 1/2"	POP		PFJ			
24112CA	3	3/4" x 3 1/2"	POP		PFJ	OAK		
PFB18M112CA	42	18mm x 3 1/2"						PFB
32112HCA	3	1" x 3 1/2"	POP		PFJ			
PFB25M112HCA	42	25mm x 3 1/2"						PFB
2488CA	3	3/4" x 2 3/4"	POP		PFJ	OAK		
PFP2288CA	48	1 1/16" x 2 3/4" x 15'					PFP	
32136CA	3	1" x 4 1/4"	POP	RFJ	PFJ			
24104BVCA	4	3/4" x 3 1/4"	POP	RFJ				
24104DD1CA	4	3/4" x 3 1/4"			PFJ			
2488R18CA	4	3/4" x 2 3/4"			PFJ			
24112R18CA	4	3/4" x 3 1/2"	POP		PFJ			
PFB24112R18CA	42	3/4" x 3 1/2"						PFB
PFP21112R18CA	49	2 1/32" x 3 1/2" x 15'					PFP	
24136R18CA	4	3/4" x 4 1/4"		RFJ				
24136ECA	5	3/4" x 4 1/4"	POP	RFJ				
24112ECA	5	3/4" x 3 1/2"	POP		PFJ			
32128GCA	5	1" x 4"	POP	RFJ				
24112BHCA	5	3/4" x 3 1/2"	POP					
24112PCA	5	3/4" x 3 1/2"	POP		PFJ			
32136PCA	5	1" x 4 1/4"	POP	RFJ				
2472FCA	6	3/4" x 2 1/4"	POP	RFJ				
24112FCA	6	3/4" x 3 1/2"			PFJ			
24112RFCA	6	3/4" x 3 1/2"		RFJ				
24136RFCA	6	3/4" x 4 1/4"		RFJ				
24168RFCA	6	3/4" x 5 1/4"	POP	RFJ				
24112RDCA	7	3/4" x 3 1/2"			PFJ			
24136RDCA	7	3/4" x 4 1/4"			PFJ			
24112BCA	7	3/4" x 3 1/2"	POP		PFJ			
2488BCA	7	3/4" x 2 3/4"		RFJ				
24136BCA	7	3/4" x 4 1/4"		RFJ				
PFB18M112ULCA	42	18mm x 3 1/2"						PFB
PFB25M112CA	42	25mm x 3 1/2"						PFB
FJPWM366	48	1 1/16" x 2 1/4" x 14'					FJP	
PFP22112WCA	48	1 1/16" x 3 1/2" x 15'					PFP	
FJP20112BHCA	49	5/8" x 3 1/2" x 15'					FJP	
PFPWM444	49	1 1/16" x 3 1/2" x 17'					PFP	

BASE CAPS

PROFILE #	PAGE #	DIMENSION	POPLAR	RAW FINGER JOINTED POPLAR	PRIMED FINGER JOINTED POPLAR	OAK	PRIMED FINGER JOINTED PINE	PRIMED MDF
1723BDBC	10	1 7/32" x 2 3/32"	POP					
2148CB	10	2 1/32" x 1 1/2"	POP	RFJ		OAK		
2244BC	10	1 1/16" x 1 3/8"	POP			OAK		
2250BJB	10	1 1/16" x 1 9/16"	POP	RFJ				

Shaded items share a similar profile, but differ in dimension or species.



BASES

PROFILE #	PAGE #	DIMENSION	POPLAR	RAW FINGER JOINTED POPLAR	PRIMED FINGER JOINTED POPLAR	OAK	PRIMED FINGER JOINTED PINE	PRIMED MDF
14136BVB	10	7/16" x 4 1/4"	POP					
14168BVB	10	7/16" x 5 1/4"		RFJ				
18104OGB	10	9/16" x 3 1/4"	POP		PFJ	OAK		
PFPWM663	49	9/16" x 3 1/4" x 16'					PPF	
18136OGB	10	9/16" x 4 1/4"	POP		PFJ	OAK		
18168OGB	10	9/16" x 5 1/4"	POP		PFJ			
20104BB	11	5/8" x 3 1/4"	POP	RFJ				
PFPWM623	49	9/16" x 3 1/4" x 16'					PPF	
20136BB	11	5/8" x 4 1/4"	POP	RFJ				
20168BB	11	5/8" x 5 1/4"	POP		PFJ			
FJPWM618	49	9/16" x 5 1/4" x 16'					FJP	
20136R18B	11	5/8" x 4 1/4"			PFJ			
PF17136R18B	50	17/32" x 4 1/4" x 16'					PPF	
20168R18B	11	5/8" x 5 1/4"	POP		PFJ			
PFB20168R18B	43	5/8" x 5 1/4"						PFB
PF17168R18B	50	17/32" x 5 1/4" x 16'					PPF	
20232R18B	11	5/8" x 7 1/4"			PFJ			
PFB20168R18B	43	5/8" x 7 1/4"						PFB
18136B	12	9/16" x 4 1/4"	POP		PFJ			
18168B	12	9/16" x 5 1/4"	POP		PFJ	OAK		
22104CB	12	1 1/16" x 3 1/4"	POP		PFJ	OAK		
PF18104CB	50	9/16" x 3 1/4" x 16'					PPF	
22136CB	12	1 1/16" x 4 1/4"	POP		PFJ	OAK		
PFB15M136CB	43	15mm x 4 1/4"						PFB
PF18136CB	50	9/16" x 4 1/4" x 16'					PPF	
22168CB	12	1 1/16" x 5 1/4"	POP		PFJ	OAK		
PFB15M168CB	43	15mm x 5 1/4"						PFB
PF18168CB	50	9/16" x 5 1/4" x 16'					PPF	
22232CB	12	1 1/16" x 7 1/4"	POP		PFJ	OAK		
PFB15M232CB	43	15mm x 7 1/4"						PFB
PF18232CB	50	9/16" x 7 1/4" x 16'					PPF	
20168BDB	13	5/8" x 5 1/4"			PFJ			
20232BDB	13	5/8" x 7 1/4"		RFJ				
24112BDB	13	3/4" x 3 1/2"			PFJ			
24168BDB	13	3/4" x 5 1/4"			PFJ			
24232BDB	13	3/4" x 7 1/4"			PFJ			
22168EB	14	1 1/16" x 5 1/4"	POP		PFJ	OAK		
PFB15M168EB	43	15mm x 5 1/4"						PFB
22232EB	14	1 1/16" x 7 1/4"	POP		PFJ			
PFB15M232EB	43	15mm x 7 1/4"						PFB
22136BJB	14	1 1/16" x 4 1/4"	POP		PFJ			
22168BJB	14	1 1/16" x 5 1/4"	POP		PFJ			

BACKBANDS & HEADER MATERIAL

PROFILE #	PAGE #	DIMENSION	POPLAR	RAW FINGER JOINTED POPLAR	PRIMED FINGER JOINTED POPLAR	OAK	PRIMED FINGER JOINTED PINE	PRIMED MDF
3436BB	8	1 1/16" x 1 1/8"	POP					
3636EEBB	8	1 1/8" x 1 1/8"	POP					
2432EGBB	8	3/4" x 1"	POP					
3652BB	8	1 1/8" x 1 5/8"	POP			OAK		
3660BB	8	1 1/8" x 1 7/8"	POP					
4648BB	8	1 7/16" x 1 1/2"	POP					
3248ITBB	8	1" x 1 1/2"	POP					
5668BB	8	2 1/8" x 1 3/4"	POP					
4864BB	9	1 1/2" x 2"	POP					
PG46240HM	9	1 7/16" x 7 1/2"	POP					

Shaded items share a similar profile, but differ in dimension or species.



SPECIES CHART

WHOLESALE HARDWOOD INTERIORS, INC.

CROWNS & DENTILS

PROFILE #	PAGE #	DIMENSION	POPLAR	RAW FINGER JOINTED POPLAR	PRIMED FINGER JOINTED POPLAR	OAK	PRIMED FINGER JOINTED PINE	PRIMED MDF	
20104BCR	15	5/8" x 3 1/4"	POP		PFJ	OAK			
PFPWM51	51	9/16" x 3 1/4" x 16'					PFP		
20136BCR	15	5/8" x 4 1/4"	POP		PFJ	OAK			
PFB15M136BCR	44	15mm x 4 1/4"						PFB	
PFPWM48	51	9/16" x 4 1/4" x 16'					PFP		
20168BCR	15	5/8" x 5 1/4"	POP		PFJ	OAK			
PFB15M168BCR	44	15mm x 5 1/4"						PFB	
FJPWM45	51	9/16" x 5 1/4" x 16'					FJP		
32232BCR	15	1" x 7 1/4"	POP	RFJ					
PFB18M232RBBCR	44	18mm x 7 1/4"						PFB	
24136ACR	16	3/4" x 4 1/4"	POP		PFJ	OAK			
PFP17136ACR	51	17/32" x 4 1/4" x 16'					PFP		
24168ACR	16	3/4" x 5 1/4"	POP		PFJ				
PFB18M168ACR	45	18mm x 5 1/4"						PFB	
PFP18168ACR	51	9/16" x 5 1/4" x 16'					PFP		
26232ACR	16	13/16" x 7 1/4"	POP		PFJ				
26192ACR	16	13/16" x 6"	POP		PFJ				
2488ACR	16	3/4" x 2 3/4"	POP			OAK			
24232WCR	17	3/4" x 7 1/4"	POP		PFJ				
32232ACR	17	1" x 7 1/4"	POP		PFJ				
1857CR	17	9/16" x 1 25/32"	POP			OAK			
24136CCR	18	3/4" x 4 1/4"			PFJ				
26168CCR	18	13/16" x 5 1/4"	POP		PFJ				
PFB18M168CCR	46	18mm x 5 1/4"						PFB	
26232CCR	18	13/16" x 7 1/4"	POP		PFJ				
PFB25M232CCR	46	25mm x 7 1/4"						PFB	
24136CVCR	20	3/4" x 4 1/4"		RFJ					
PFB22136COCR	45	11/16" x 4 1/4"						PFB	
24168CVCR	20	3/4" x 5 1/4"	POP		PFJ				
PFB24168COCR	45	3/4" x 5 1/4"						PFB	
26232CVCR	20	13/16" x 7 1/4"			PFJ				
PFB25M224COCR	45	25mm x 7"						PFB	
26168DCD	21	13/16" x 5 1/4"	POP	RFJ					
2460CD	21	3/4" x 1 7/8"	POP						
26120DCR	22	13/16" x 3 3/4"	POP						
26168DCR	22	13/16" x 5 1/4"	POP		PFJ				
1620D	22	1/2" x 5 5/8"	POP			OAK			
1724ROPE	22, 29	17/32" x 3/4"		SEE PAGE 58 UNDER TRIM MOULDINGS FOR MORE DETAILS.					
PFB20M232CR	46	20mm x 7 1/4"						PFB	
PFB25M202OGCR	46	25mm x 6 5/16"						PFB	

CHAIR RAILS

PROFILE #	PAGE #	DIMENSION	POPLAR	RAW FINGER JOINTED POPLAR	PRIMED FINGER JOINTED POPLAR	OAK	PRIMED FINGER JOINTED PINE	PRIMED MDF
20168CHB	25	5/8" x 5 1/4"	POP	RFJ				
16104CH	25	1/2" x 3 1/4"	POP					
2288CH	25	11/16" x 2 3/4"	POP	RFJ				
22104CH	25	11/16" x 3 1/4"	POP		PFJ			
32104CH	25	1" x 3 1/4"	POP		PFJ			

Shaded items share a similar profile, but differ in dimension or species.



MULLS

PROFILE #	PAGE #	DIMENSION	POPLAR	RAW FINGER JOINTED POPLAR	PRIMED FINGER JOINTED POPLAR	OAK	PRIMED FINGER JOINTED PINE	PRIMED MDF
0832M	25	1/4" X 1"	POP					
0840M	25	1/4" X 1 1/4"	POP					
0848M	25	1/4" X 1 1/2"	POP					
0856M	25	1/4" X 1 3/4"	POP					
0864M	25	1/4" X 2"	POP			OAK		
0872M	25	1/4" X 2 1/4"	POP					
0880M	25	1/4" X 2 1/2"	POP					
0888M	25	1/4" X 2 3/4"	POP					
0896M	25	1/4" X 3"	POP					

WINDOW STOOLS & STOPS

PROFILE #	PAGE #	DIMENSION	POPLAR	RAW FINGER JOINTED POPLAR	PRIMED FINGER JOINTED POPLAR	OAK	PRIMED FINGER JOINTED PINE	PRIMED MDF
2472WSA	26	3/4" X 2 1/4"	POP			OAK		
2472WS	26	3/4" X 2 1/4"	POP					
40104WS-NR	26	1 1/4" X 3 1/4"	POP					
40104WS	26	1 1/4" X 3 1/4"	POP					
24136WS	26	3/4" X 4 1/4"	POP					
24168WS	26	3/4" X 5 1/4"	POP	RFJ				
1026S	26	5/16" X 1 3/16"	POP			OAK		
1144S	26	1 1/32" X 1 3/8"	POP			OAK		
1234S	26	3/8" X 1 1/16"	POP					
1256S	26	3/8" X 1 3/4"	POP			OAK		
1280S	26	3/8" X 2 1/2"	POP					
1296S	26	3/8" X 3"	POP					

PANEL & BED MOULDINGS

PROFILE #	PAGE #	DIMENSION	POPLAR	RAW FINGER JOINTED POPLAR	PRIMED FINGER JOINTED POPLAR	OAK	PRIMED FINGER JOINTED PINE	PRIMED MDF	
1840BM	27	9/16" X 1 1/4"	POP						
1846BM	27	9/16" X 1 7/16"	POP		PFJ	OAK			
1632CKPM	27	1/2" X 1"	POP						
1648M	27	1/2" X 1 1/2"	POP						
2048P	27	5/8" X 1 1/2"		RFJ					
2424PR	27	3/4" X 3/4"	POP			OAK			
2432PM	27	3/4" X 1"	POP						
2456PM	27	3/4" X 1 3/4"	POP		PFJ				
3240PR	27	1 1/4" X 1"	POP						
2664P	27	1 3/16" X 2"	POP		PFJ	OAK			
2664PR	27	1 3/16" X 2"	POP			OAK			
3264PR	27	1" X 2"	POP	RFJ		OAK			
3264PRJ	27	1" X 2"	POP						
3264PJ	27	1" X 2"	POP						
2048KWPM	28	5/8" X 1 1/2"	POP						
1242BM	28	3/8" X 1 5/16"	POP						
U-589-IC	28	3/8" X 1 5/16"		----- Resin Material -----					



SPECIES CHART

WHOLESALE HARDWOOD INTERIORS, INC.

TRIM MOULDINGS

PROFILE #	PAGE #	DIMENSION	POPLAR	RAW FINGER JOINTED POPLAR	PRIMED FINGER JOINTED POPLAR	OAK	PRIMED FINGER JOINTED PINE	WHITE OAK	MAPLE	HICKORY	PINE	CHERRY
5448CM	9,28	1 11/16" X 1 1/2"	POP									
624	28	3/16" X 3/4"	POP			OAK						
1224T	28	3/8" X 3/4"	POP									
1212Q	28	3/8" X 3/8"	POP			OAK						
1416OS	28	7/16" X 1/2"	POP			OAK						
1416GB	28	7/16" X 1/2"	POP			OAK						
816	28	1/4" X 1/2"	POP									
1224KR	28	3/8" X 3/4"	POP									
2323B	28	23/32" X 23/32"	POP			OAK						
1624A	28,50	1/2" X 3/4"	POP		PFJ	OAK	FJP	WO	M	H		
1624R18	28	1/2" X 3/4"	POP		PPO							
FJP1424R18	50	7/16" X 3/4"					FJP					
1624	29	1/2" X 3/4"	POP			OAK		WO				
1624C	29	1/2" X 3/4"	POP			OAK		WO				
1640A	29	1/2" X 1 1/4"	POP			OAK						
1640BN	9,29	1/2" X 1 1/4"	POP			OAK						
1640-2RE116	29	1/2" X 1 1/4"	POP									
2024SC	29	5/8" X 3/4"	POP		PFJ	OAK		WO	M	H		
2424C	29	3/4" X 3/4"	POP			OAK						
2424IC	29	3/4" X 3/4"	POP									
2424Q	29	3/4" X 3/4"	POP			OAK						
FJP2222Q	50	11/16" X 11/16"					FJP					
2448HR	29	3/4" X 1 1/2"	POP									
2424OC	29	3/4" X 3/4"	POP			OAK						
3636OC	29	1 1/8" X 1 1/8"	POP			OAK						
4040ROD	29	1 1/4" DIAMETER	POP									
1124ROPE	29	11/32" X 3/4"	POP			OAK			M	H		
1724ROPE	22,29	17/32" X 3/4"	POP			OAK			M			C

Tounge & Groove

PROFILE #	PAGE #	DIMENSION	POPLAR	RAW FINGER JOINTED POPLAR	PRIMED FINGER JOINTED POPLAR	OAK	PRIMED FINGER JOINTED PINE	PRIMED MDF
1296TVGBD	35	3/8" X 3" (FACE)	POP			OAK		
PFB18M168TVG	47	18mm X 5 1/4" (FACE)						PFB
24108TVGBD	35	3/4" X 3 3/8" (FACE)	POP			OAK		
24160TVGBD	35	3/4" X 5" (FACE)	POP	RFJ				
2496TVG	35	3/4" X 3" (FACE)	POP					
24128TVG	35	3/4" X 4" (FACE)	POP					
24160TVG	35	3/4" X 5" (FACE)	POP			OAK		

Shiplap

PROFILE #	PAGE #	DIMENSION	POPLAR	RAW FINGER JOINTED POPLAR	PRIMED FINGER JOINTED POPLAR	OAK	PRIMED FINGER JOINTED PINE	PRIMED MDF
24168SL18	37	3/4" X 5 1/4"	POP	RFJ				
PFB24160QRKTAG	47	3/4" X 5" (FACE)						PFB
PFP18172SL18	52	9/16" X 5 3/8"					PFP	
24232SL18	37	3/4" X 7 1/4"	POP	RFJ				
PFB24224QRKTAG	47	3/4" X 7" (FACE)						PFB
PFP18236SL18	52	9/16" X 7 3/8"					PFP	

Shaded items share a similar profile, but differ in dimension or species.

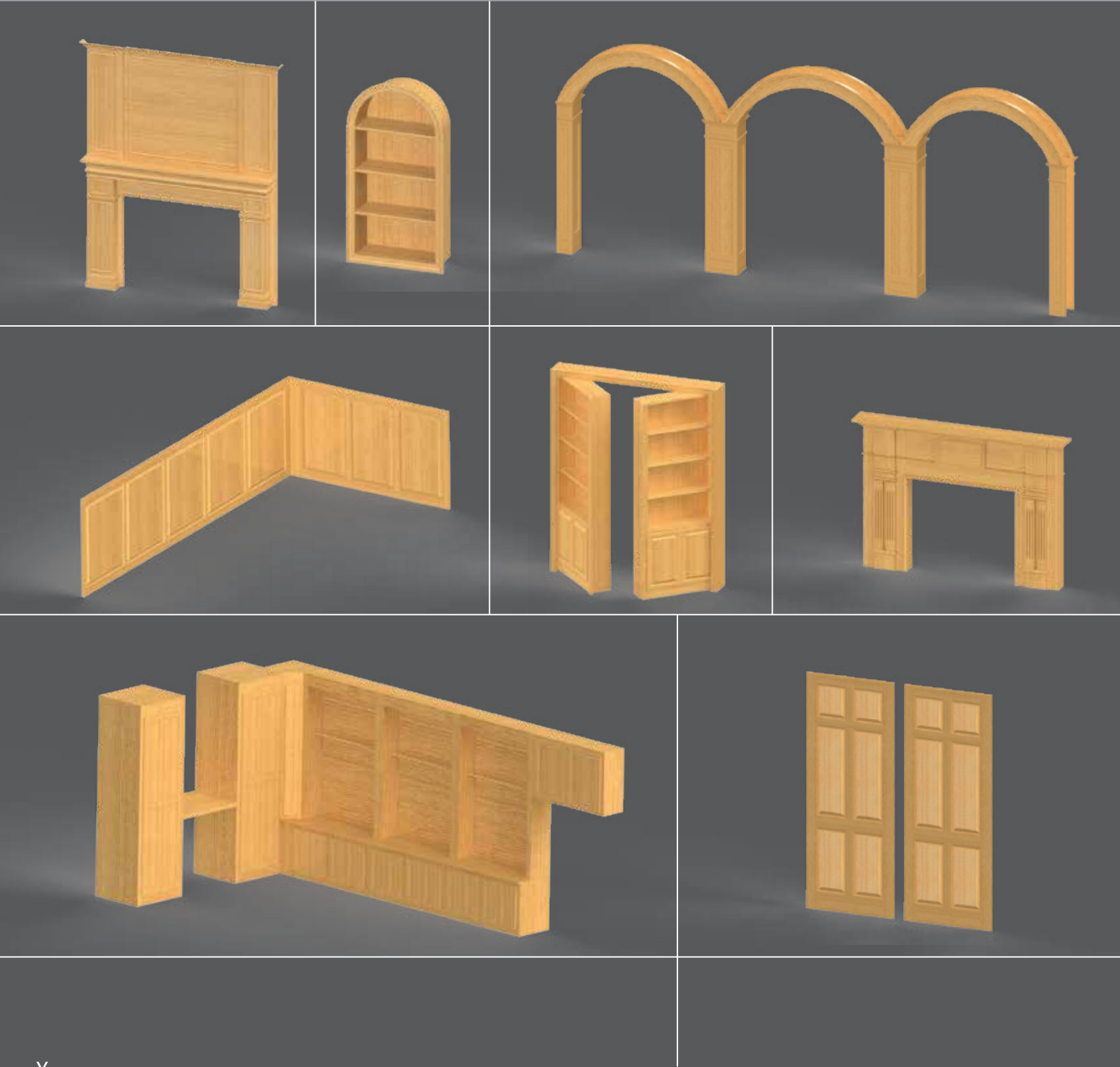

Y

WHI's Design Team has been drawing custom products since our inception in 1985. Above are a few drawings that became a reality for some of our satisfied customers.

WHI's "The Shop" is where these drawings come to life. Years of skill and craftsmanship have gone into making The Shop what it is today. We invite you to find craftsmen that can compete with the level of expertise our shop has to offer.

X

General Information

Moulding Tips

- Before finishing, lightly sand all material.
- Due to moisture control issues, we recommend that all surfaces and edges be finished as quickly as possible.
- It is recommended to keep all interior mouldings and millwork inside a humidity controlled area while on the job site. To ensure proper moisture content, it is best to allow the material to acclimate for several days prior to installation. If you are unable to store the material in a humidity-controlled area, please keep the material off the floor. This will help prevent the material from gaining moisture from uncured concrete or a wood floor with a higher moisture content. When those conditions exist, it is best to use a vapor barrier such as a sheet of plastic to cover the material on top and bottom when it is not in use.

Lengths

- All clear hardwood species are supplied in random lengths between 3' and 16' depending upon the item. Due to these random lengths in clear species, it is acceptable to ship up to 10% overage. Finger joint poplar material is supplied in 14' through 16' lengths, also depending on the item. Finger joint items may have up to 5% of the lengths shorter than 14' and 16'.
- MDF is typically 16' in length. Some casing profiles also come in 7' precuts, 10' and 14' lengths.

Select photographs of this book are compliments of Koetter Woodworking, Inc. Copying, reproducing, transmitting or modifying any image is prohibited unless otherwise permitted by Wholesale Hardwood Interiors, Inc.





Architectural Mouldings & Millwork

Architectural Mouldings are just one of WHI's stock products. Below is a list of others products offered for your interior needs.

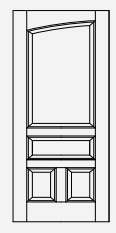

Interior Doors

• Molded • Solid Wood • Lighted • And More •
WHOLESALE HARDWOOD INTERIORS

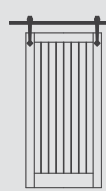
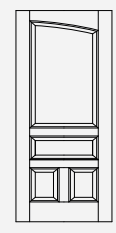

Barn Doors

WHOLESALE HARDWOOD INTERIORS

Hardware

WHOLESALE HARDWOOD INTERIORS

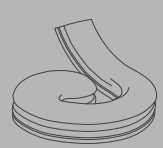

Stair Parts

WHOLESALE HARDWOOD INTERIORS

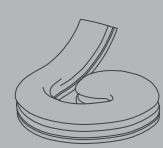

WHI Catalogs

WHI Catalogs include: Architectural Mouldings & Millwork, Solid Wood Doors and Stair Parts. If you would like a copy of these catalogs please contact us at 800-982-7404, or you may access a virtual copy online at www.wholesalehardwoodint.com.



Phone 800.982.7404
www.wholesalehardwoodint.com